



# AGENTS

8637



1

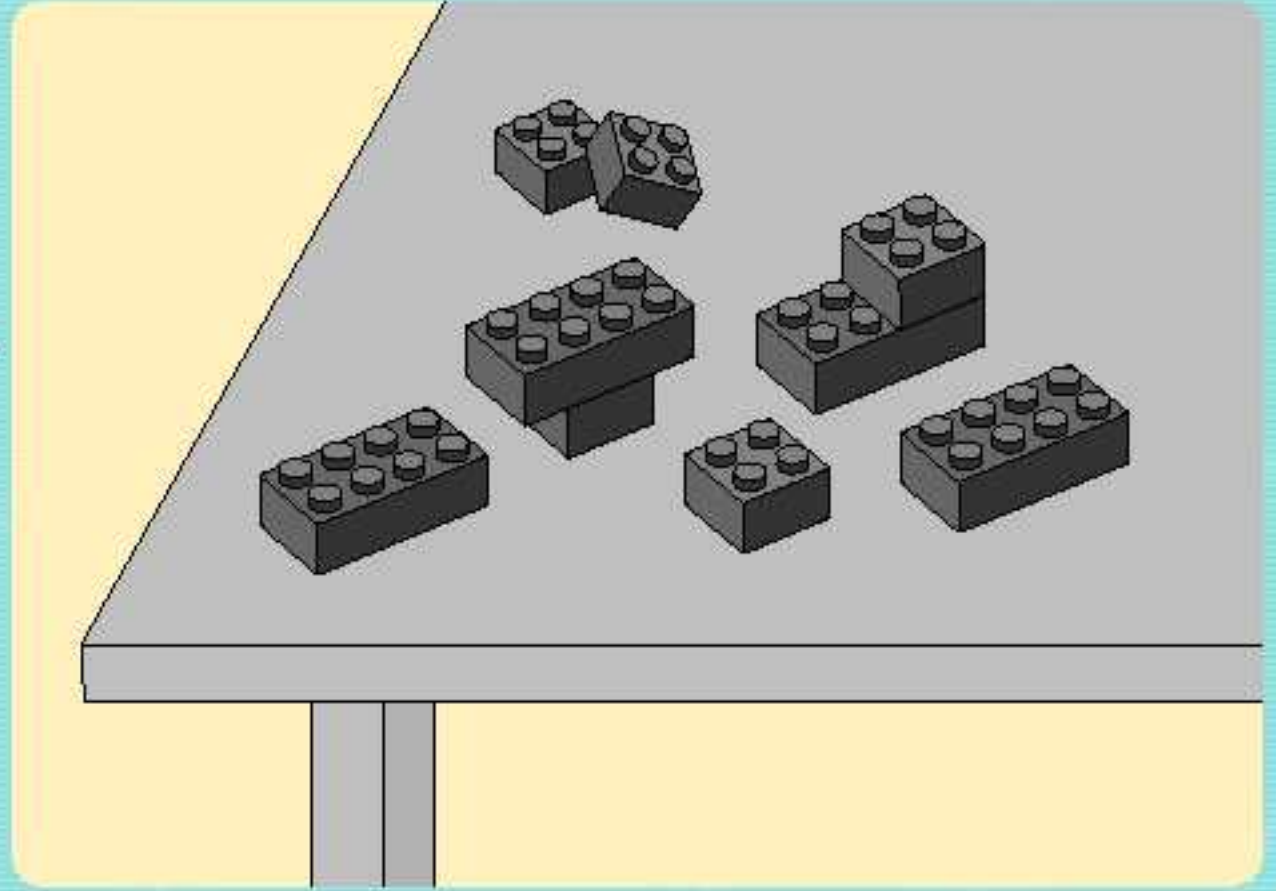
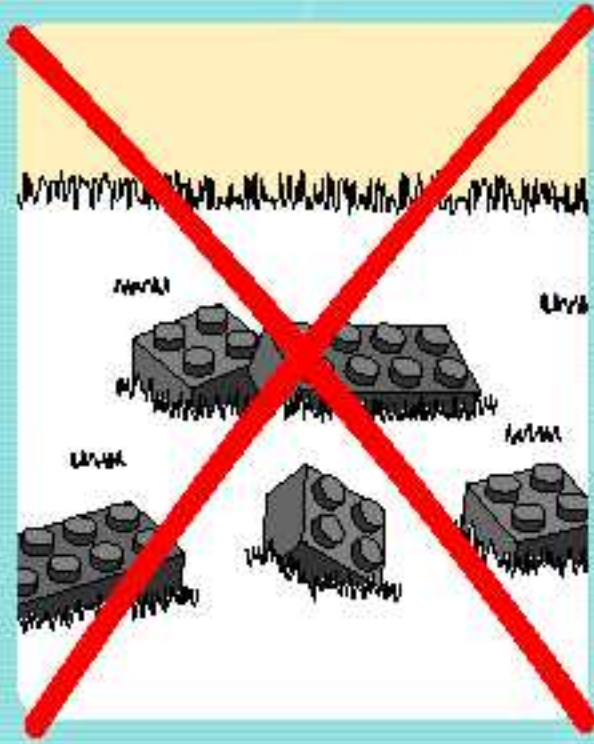

2





3

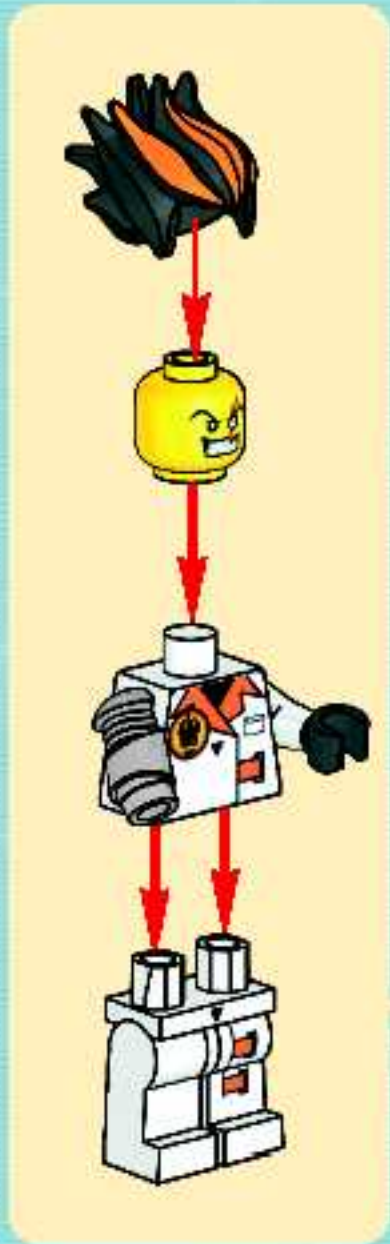

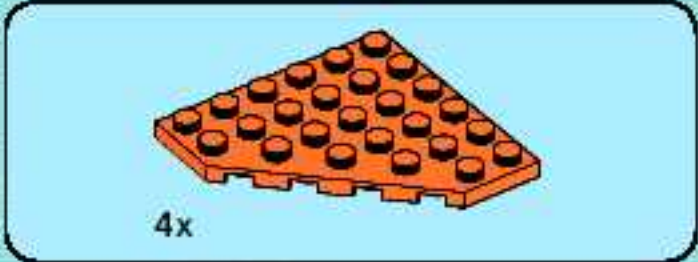

**1**

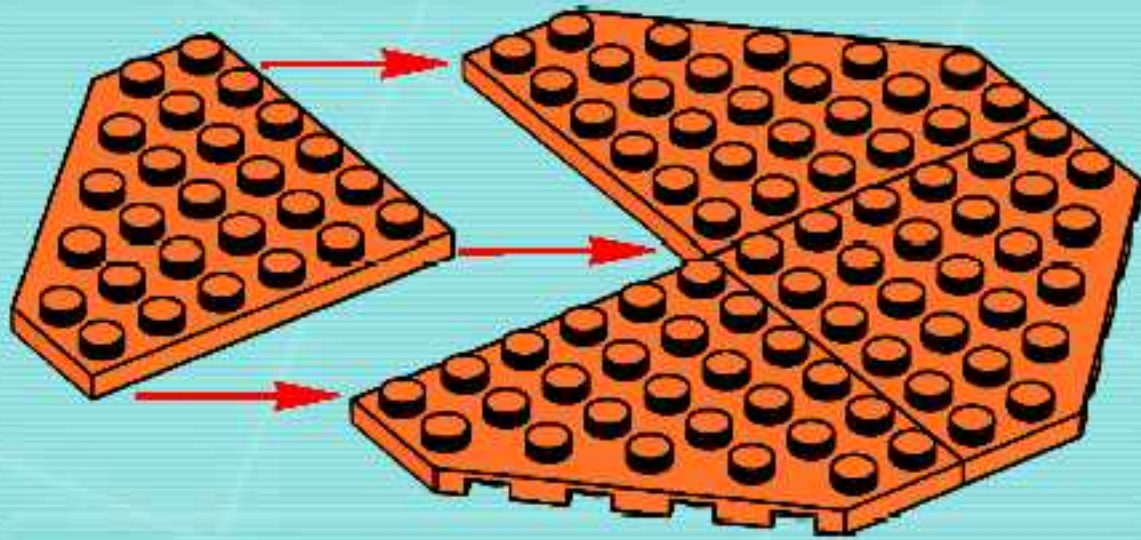

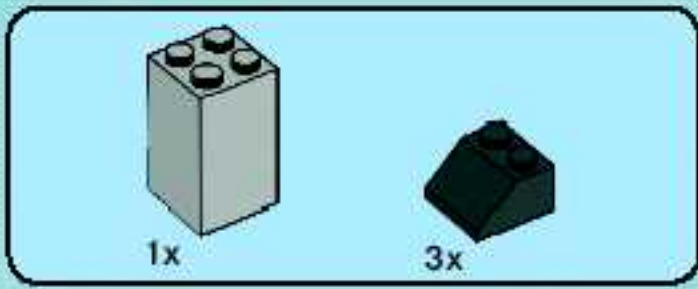

2

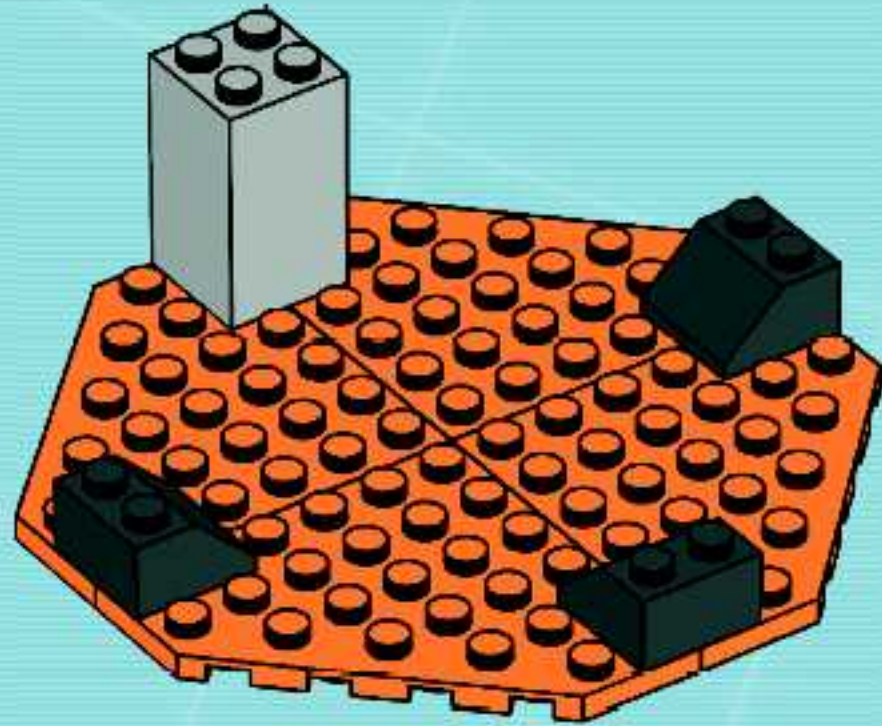

3

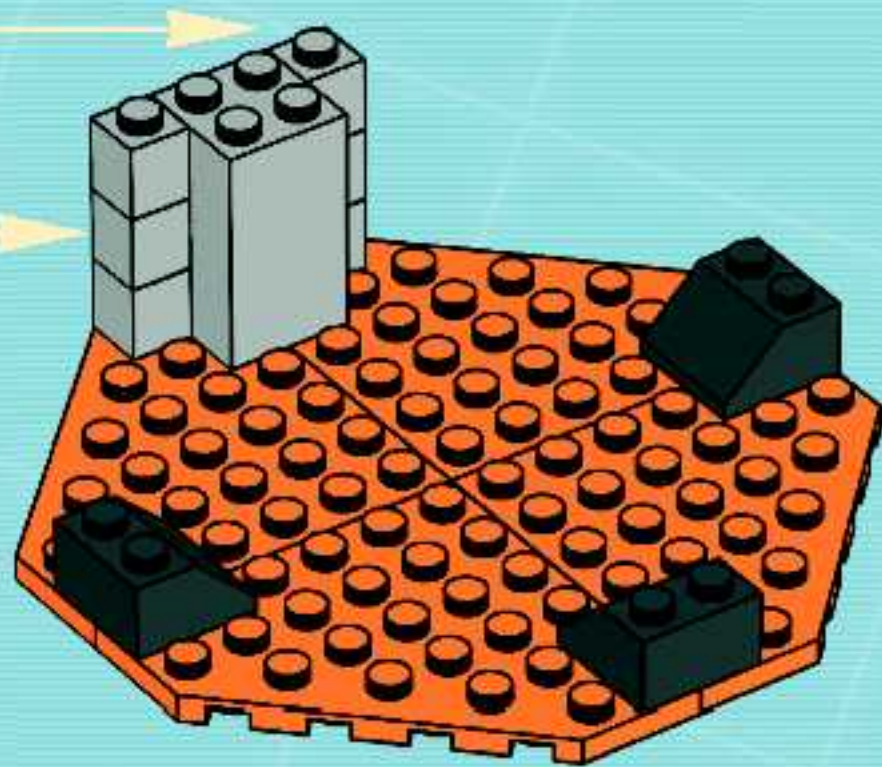
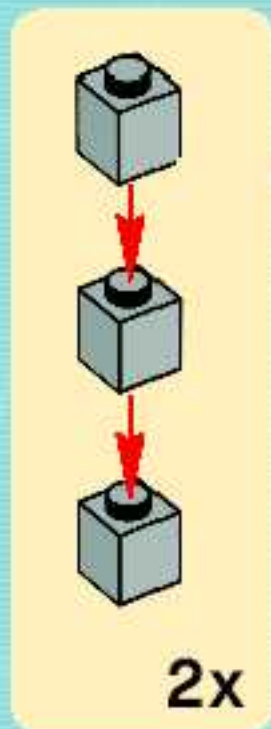

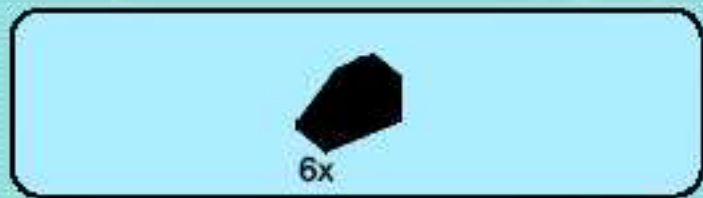

4

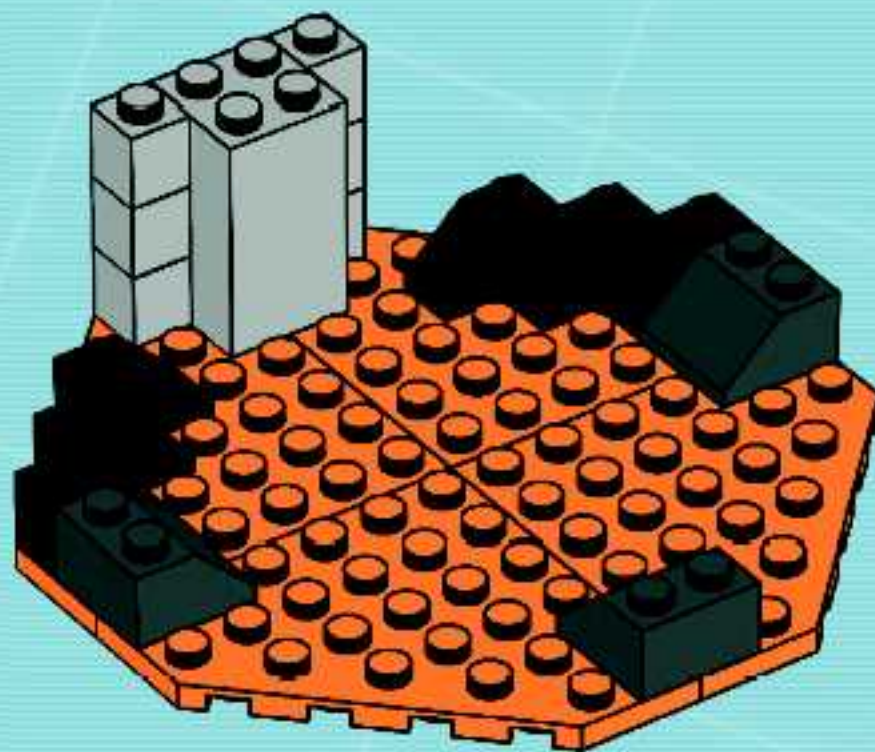

5

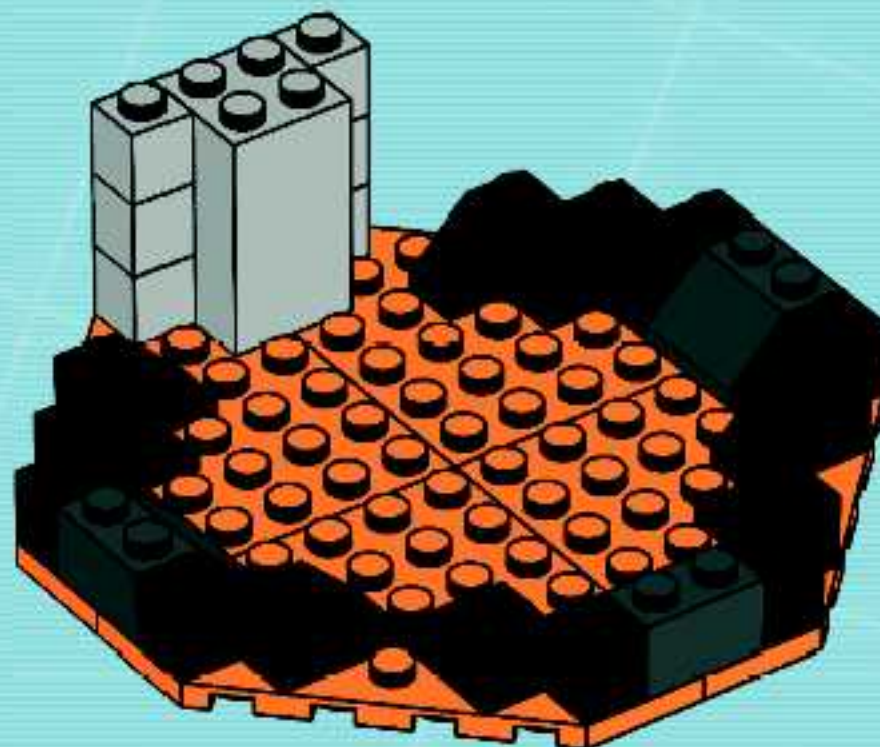

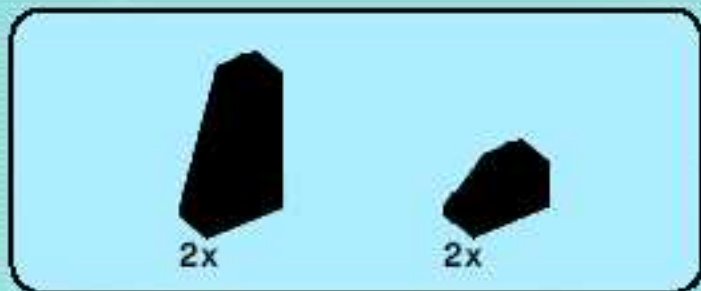

6

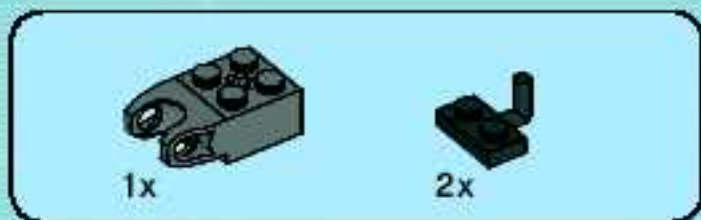
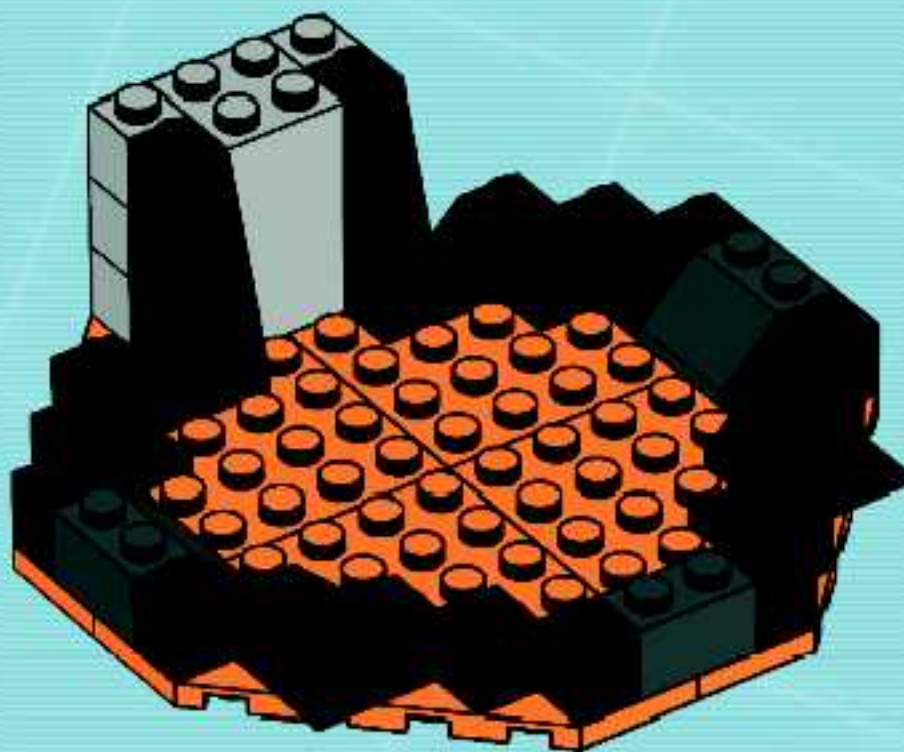

7

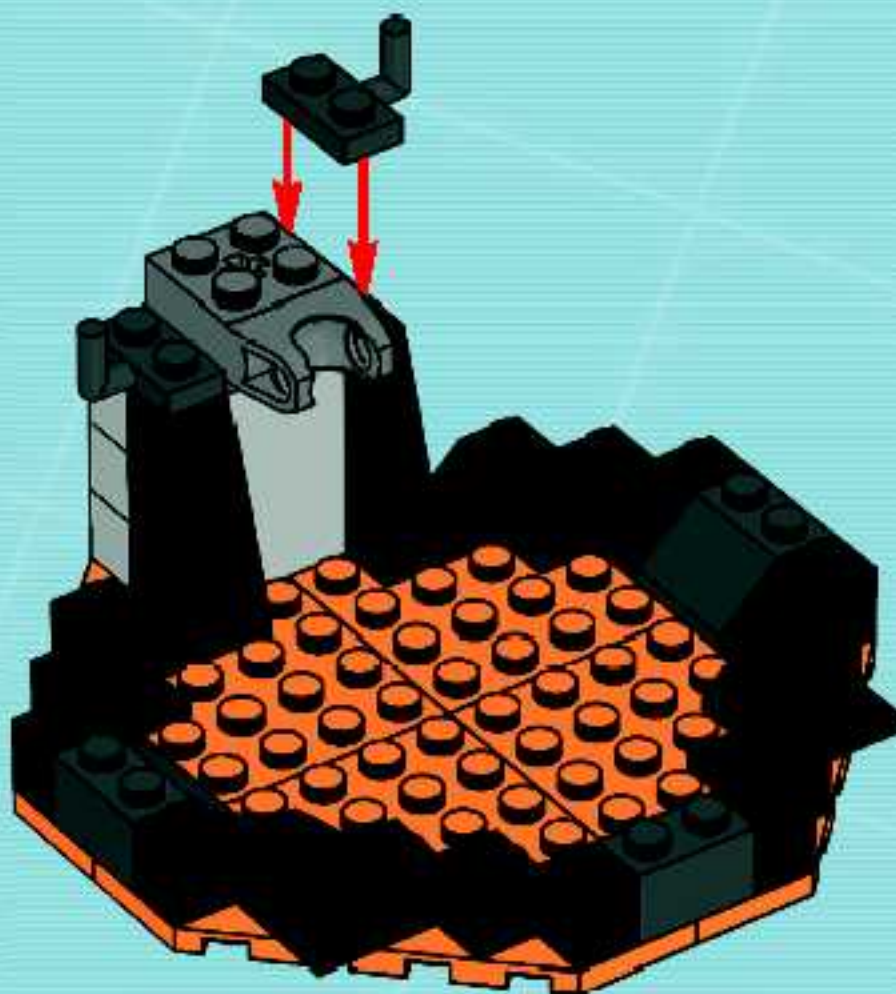



4x

8



1x

9

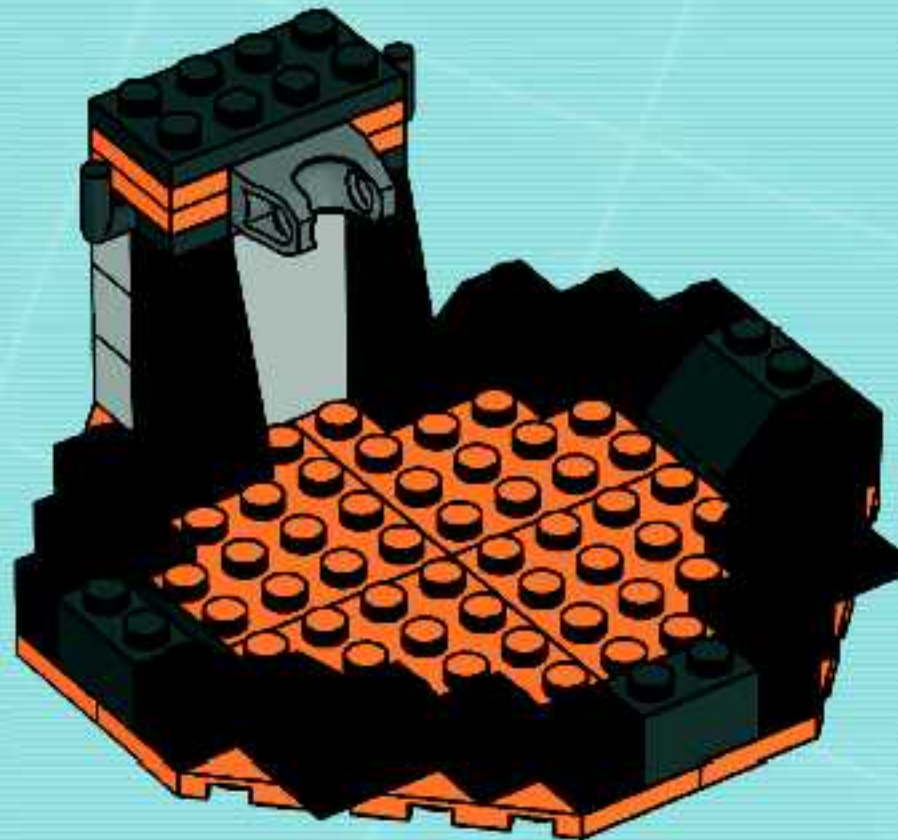



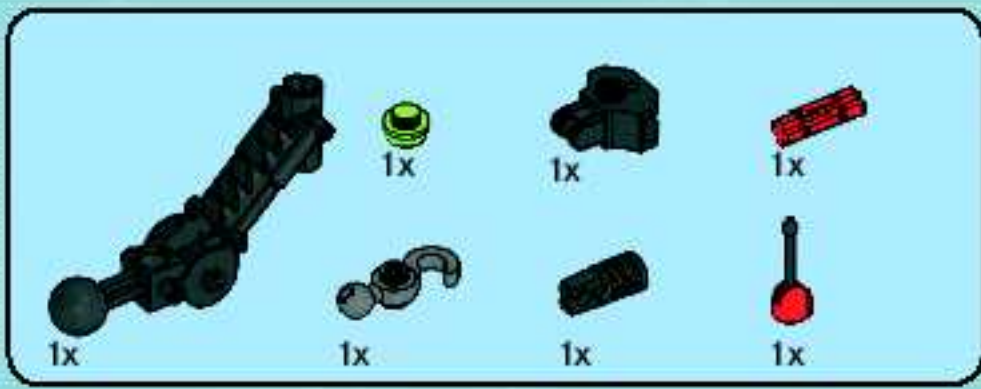

10

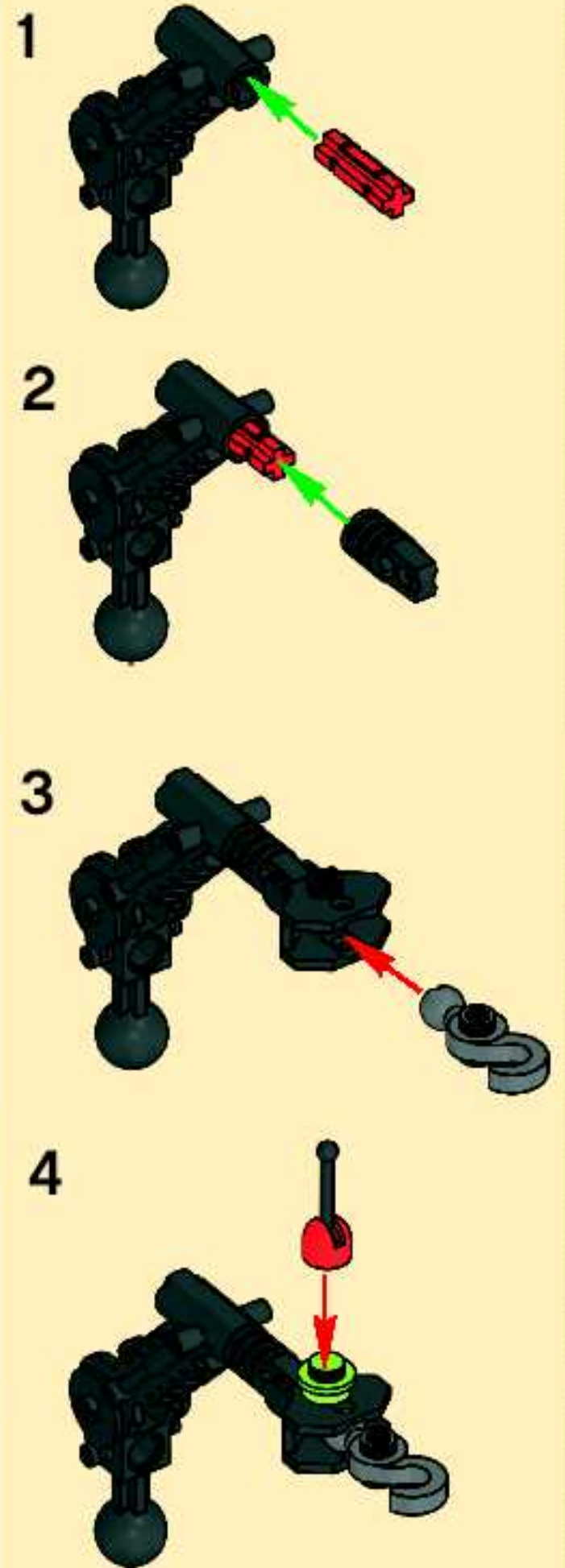
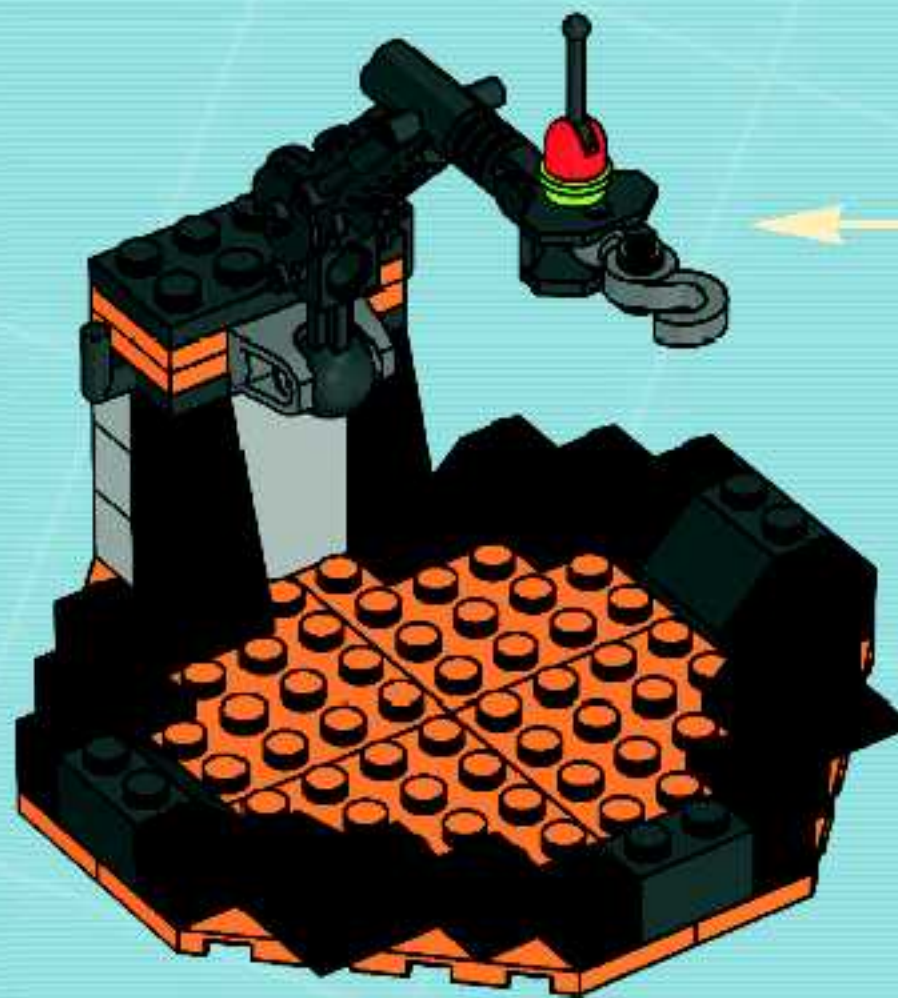



4x

11

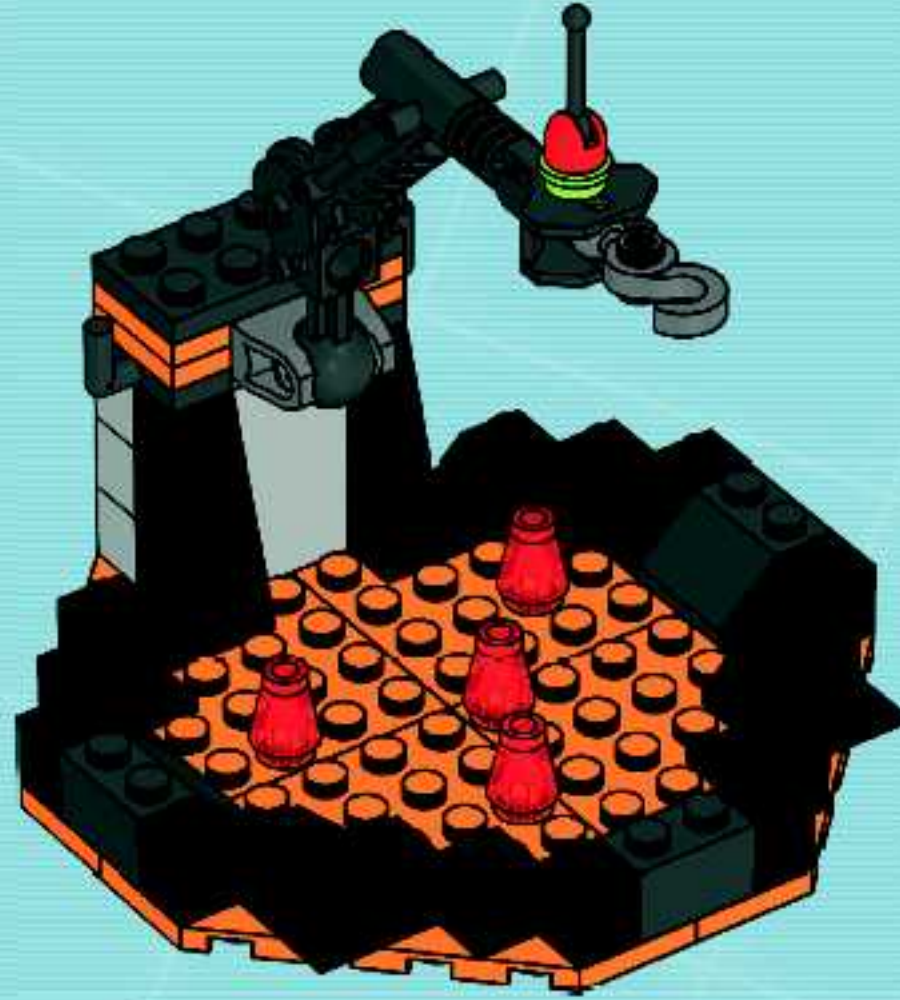

4x

12

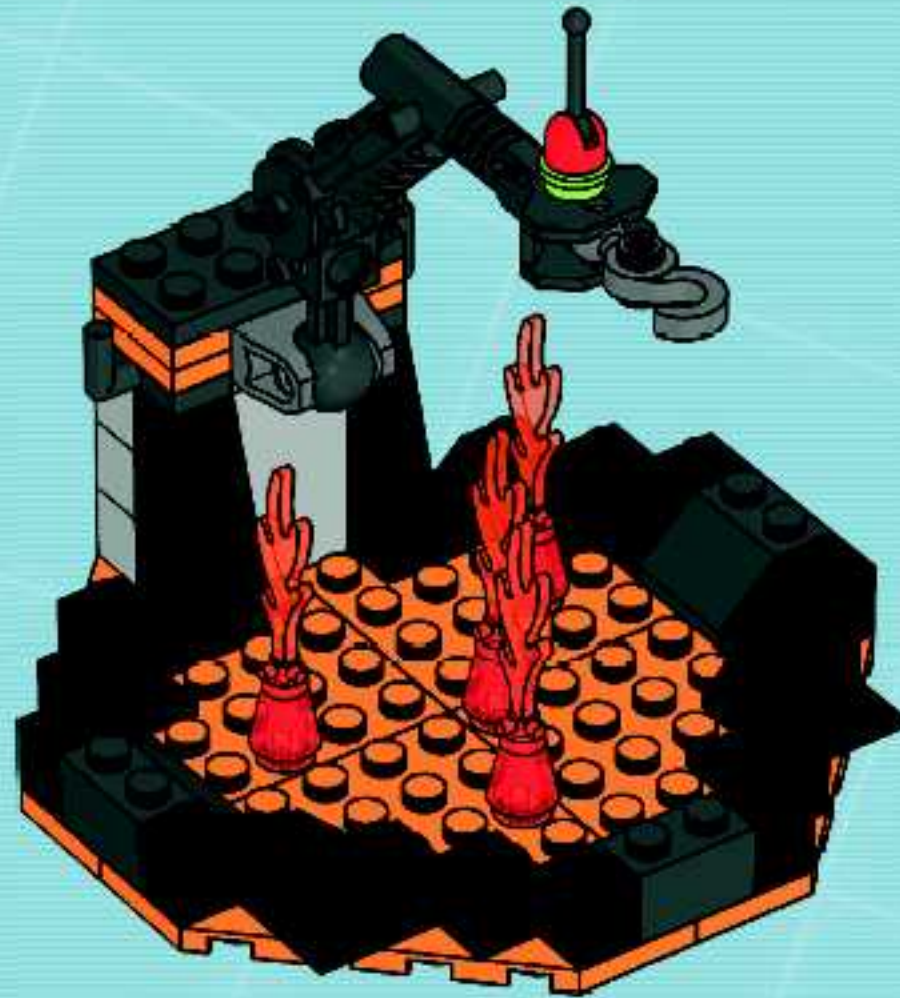



3x

# 13

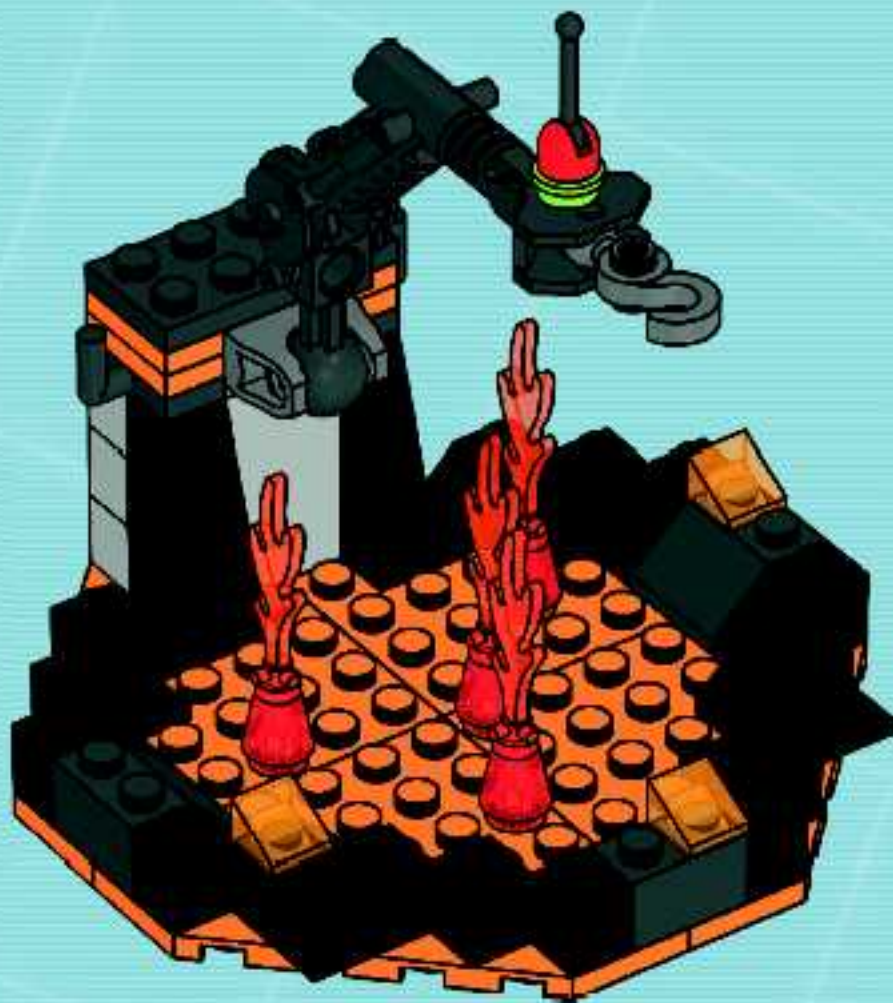

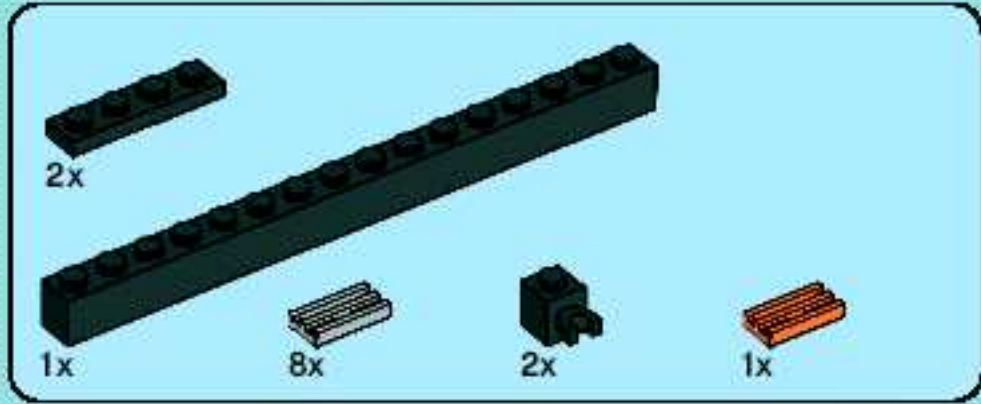

14

1

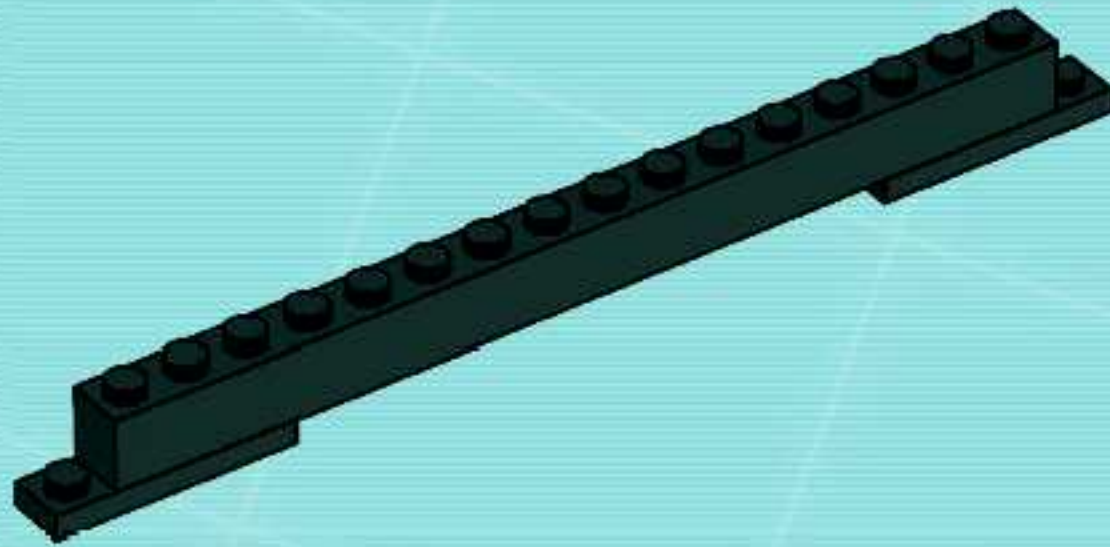

2

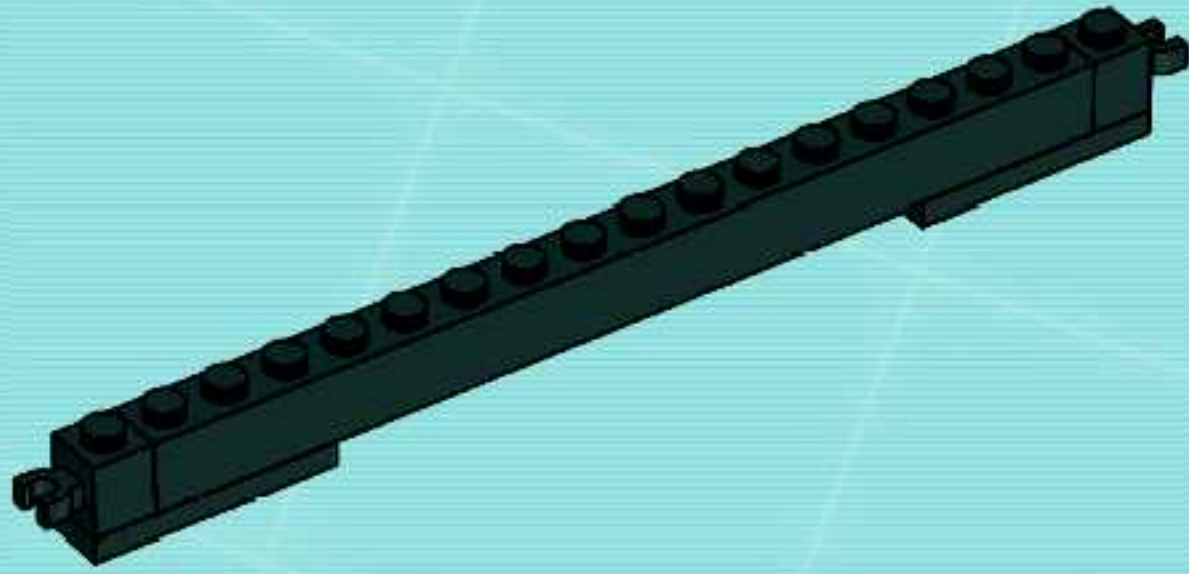

3

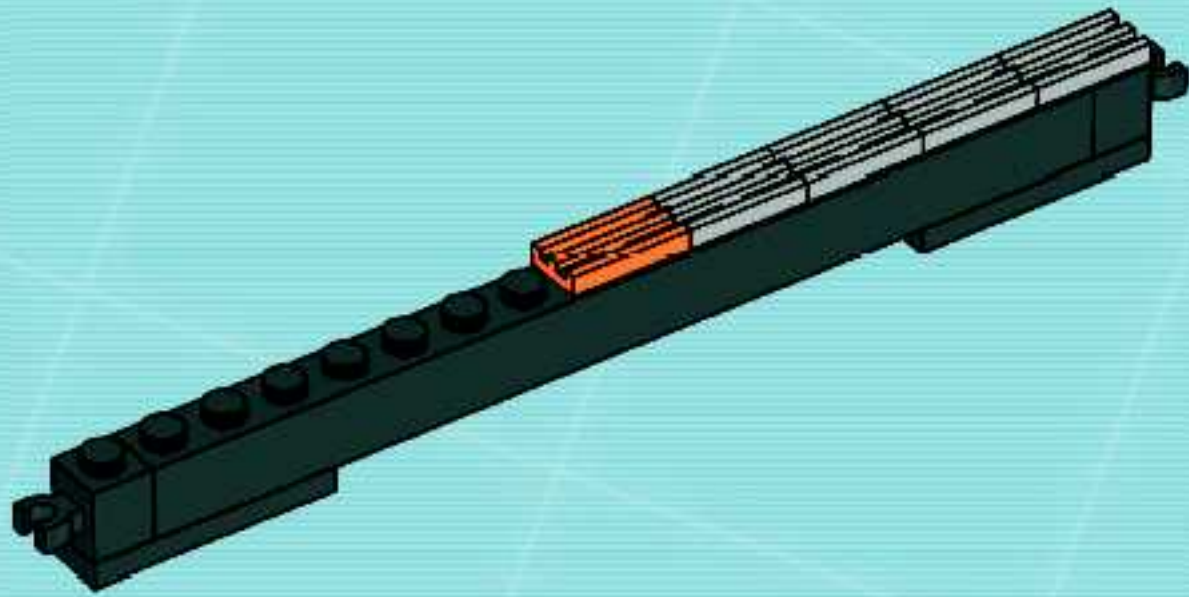

4

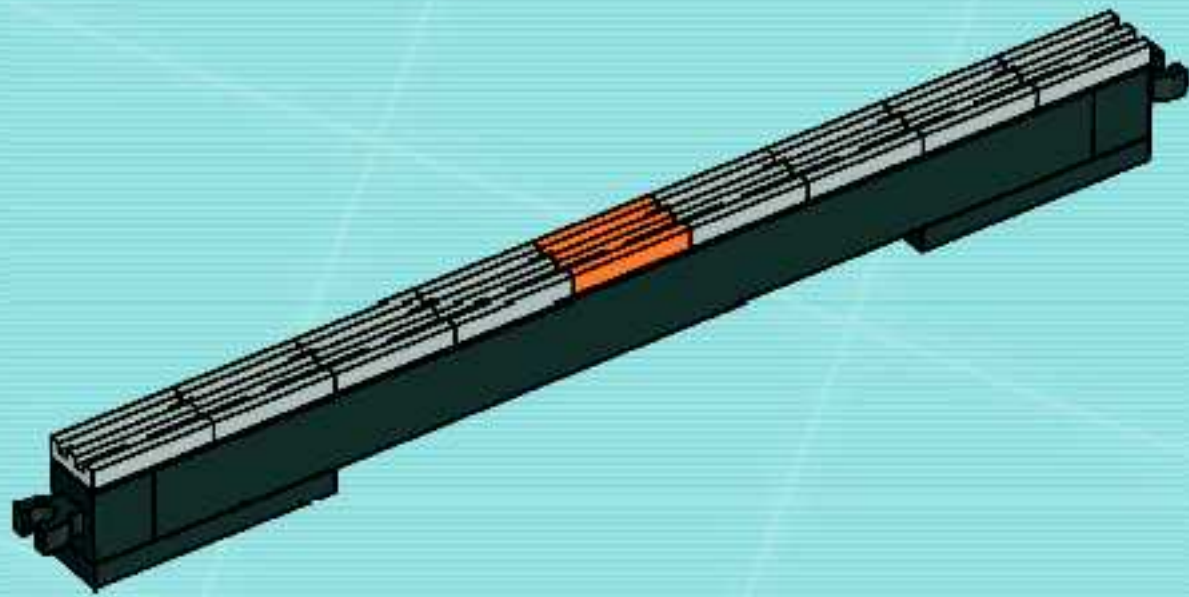

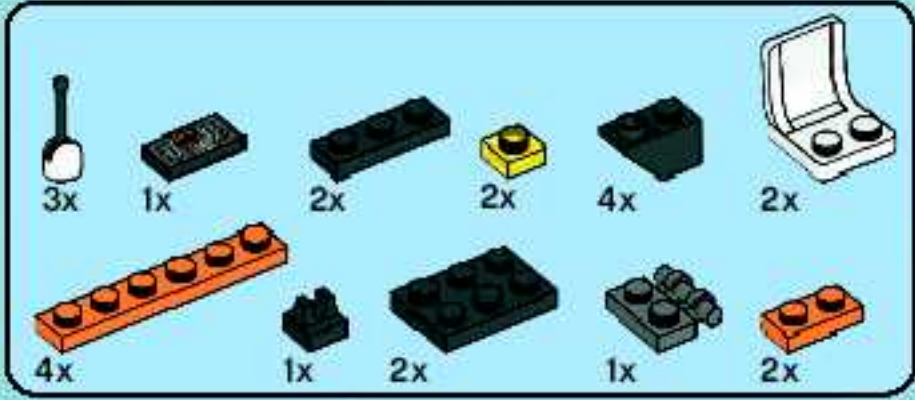
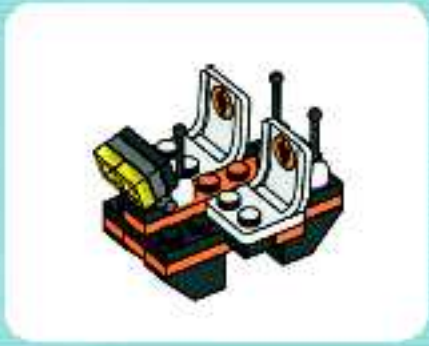

15

1

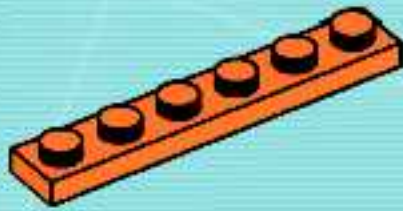

2

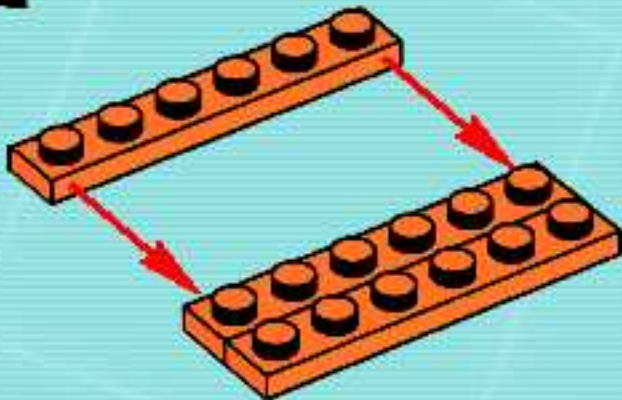

3



4

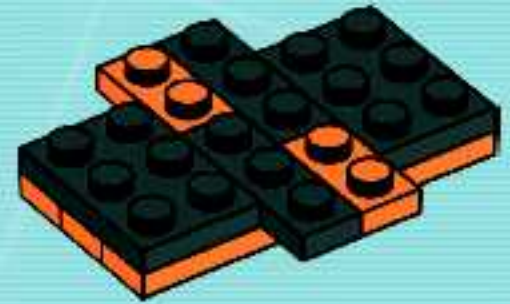

5

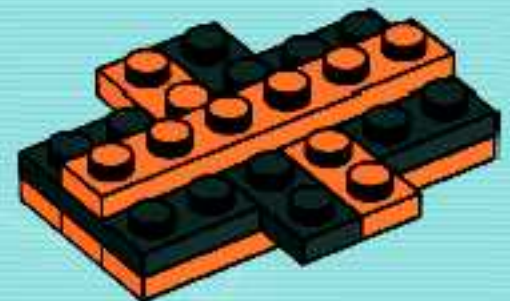

6

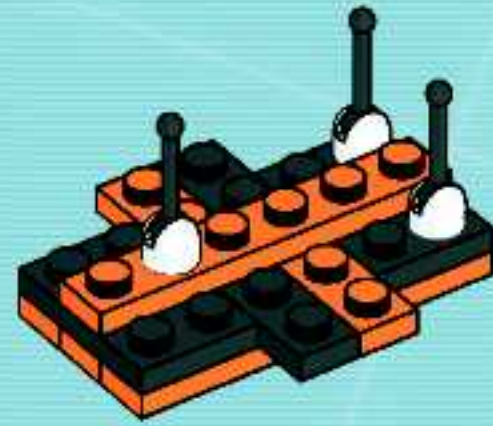

7

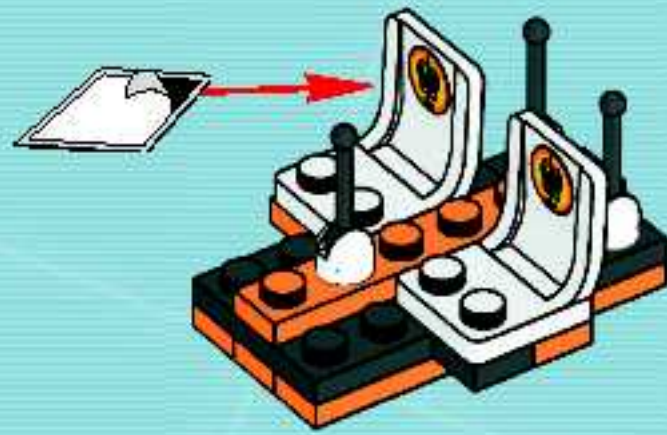

8

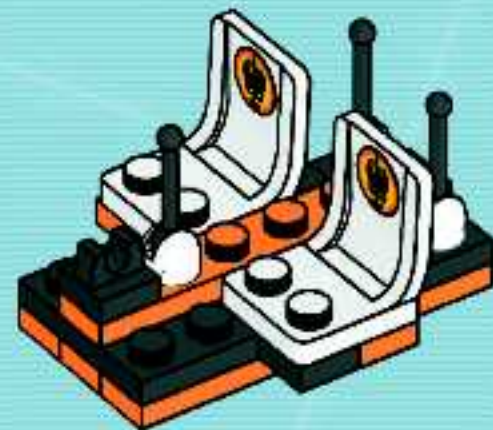

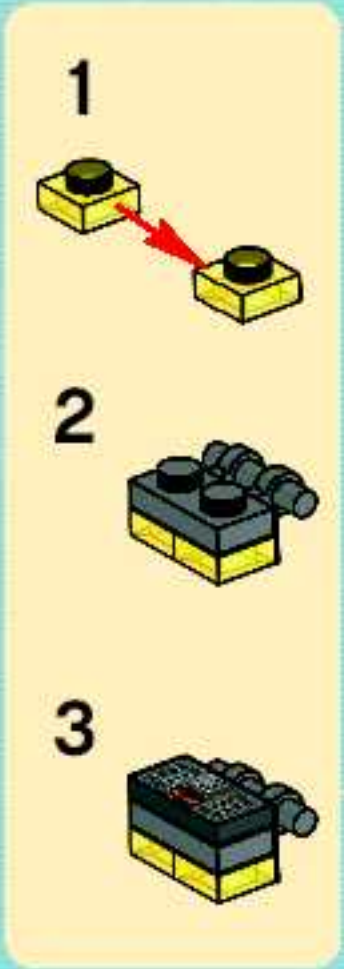

9

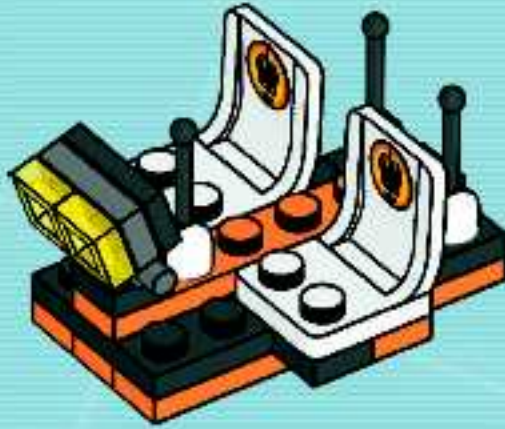

10

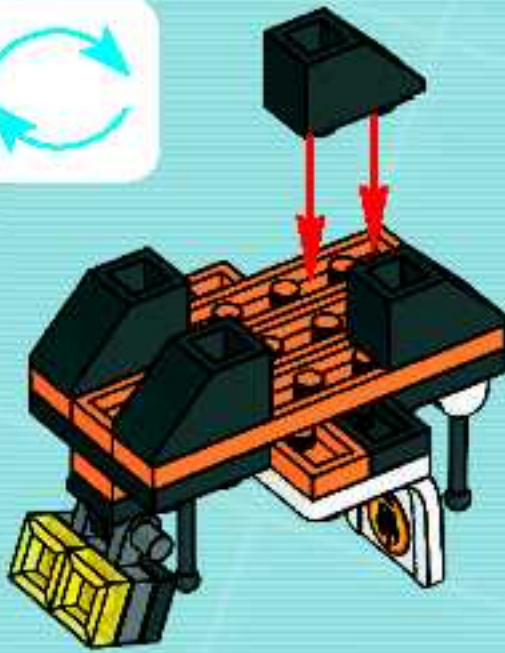



11

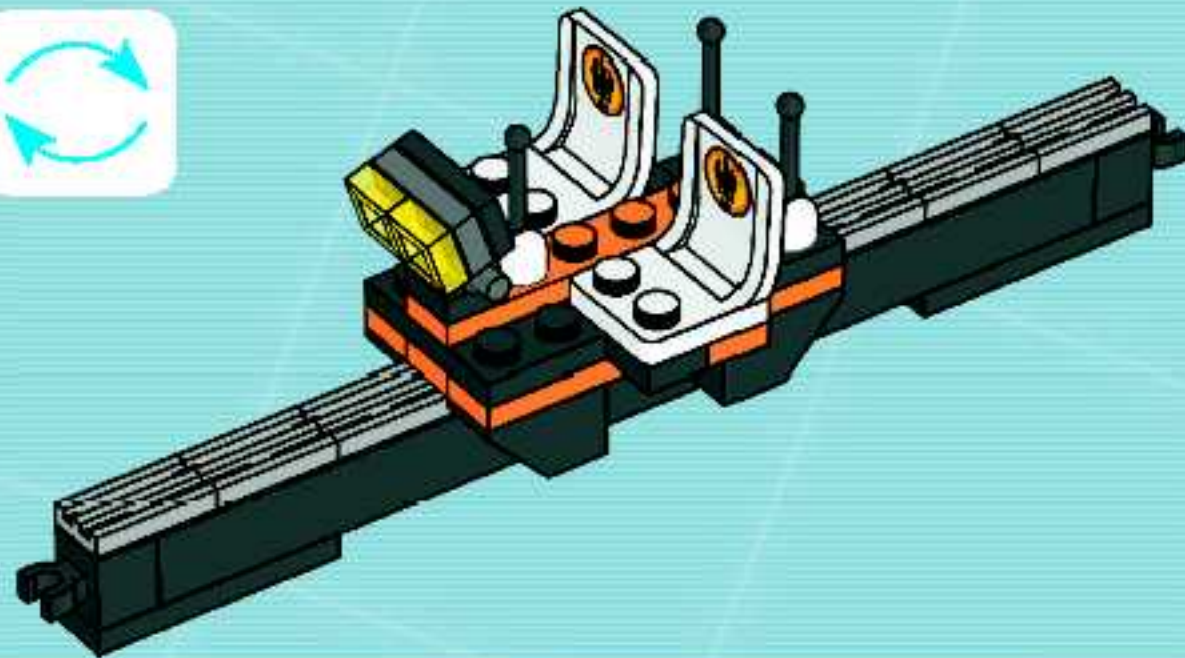

16

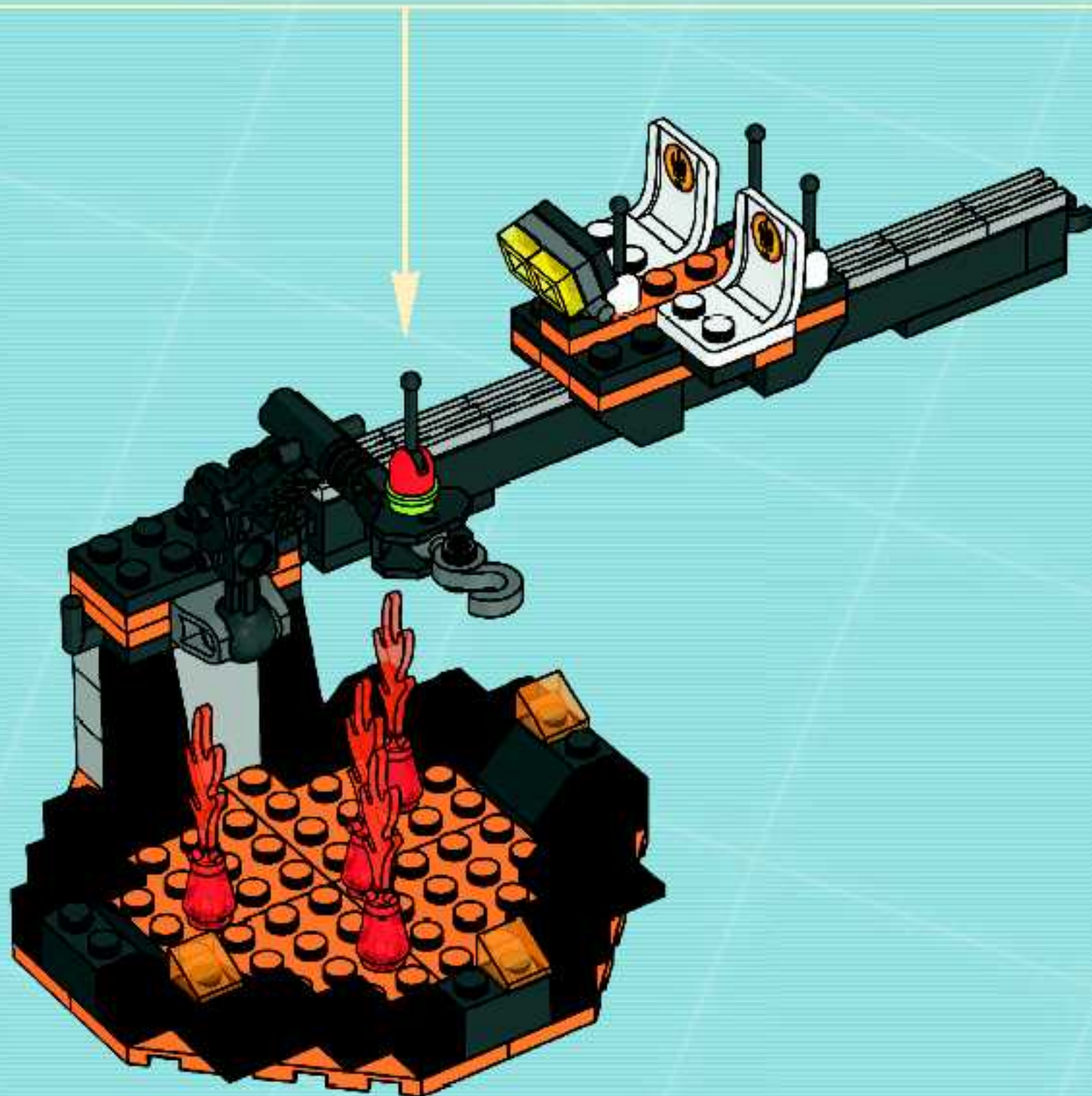

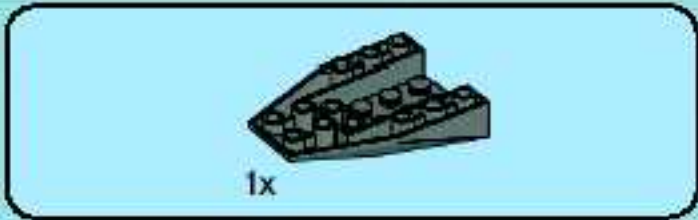

1

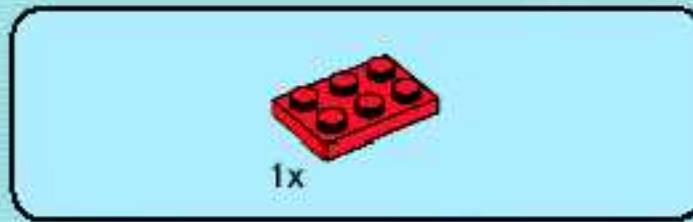
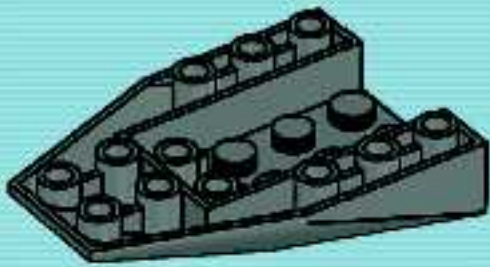

2

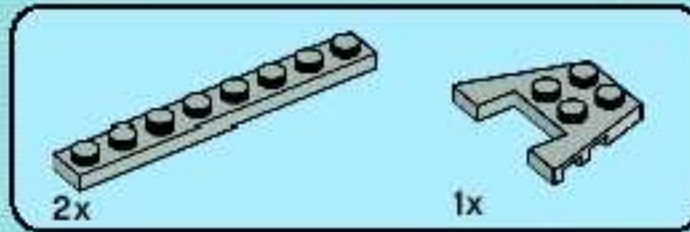
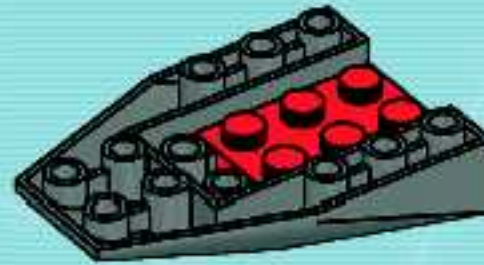

3

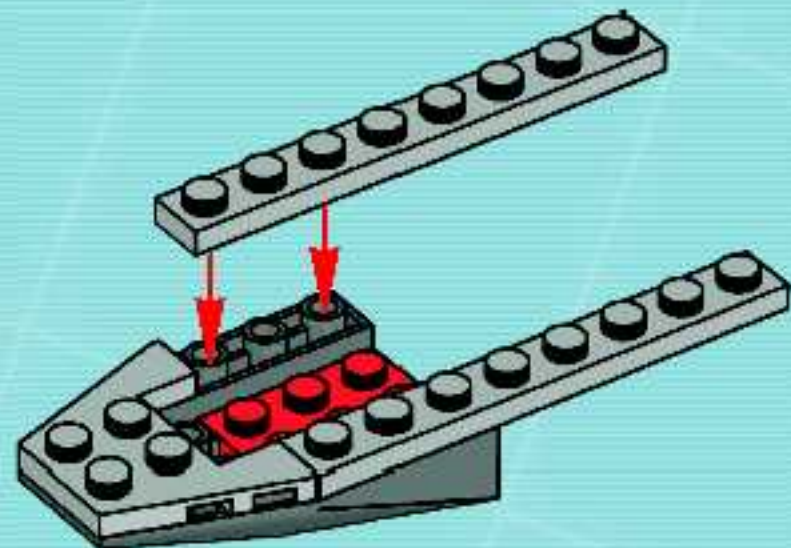

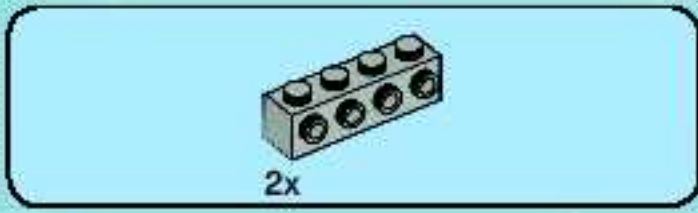

4

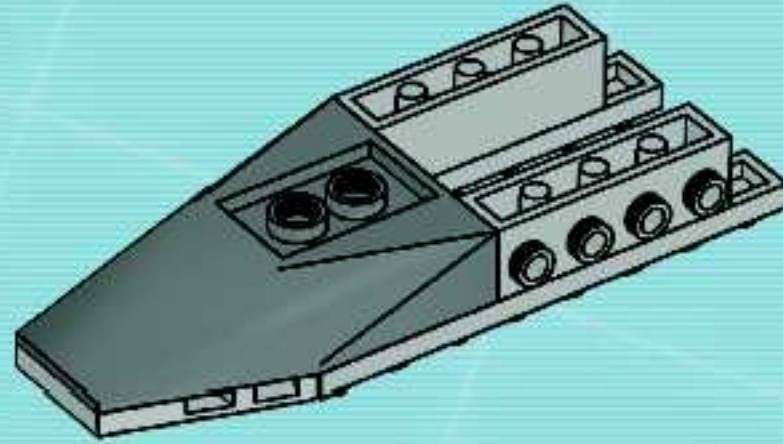

5

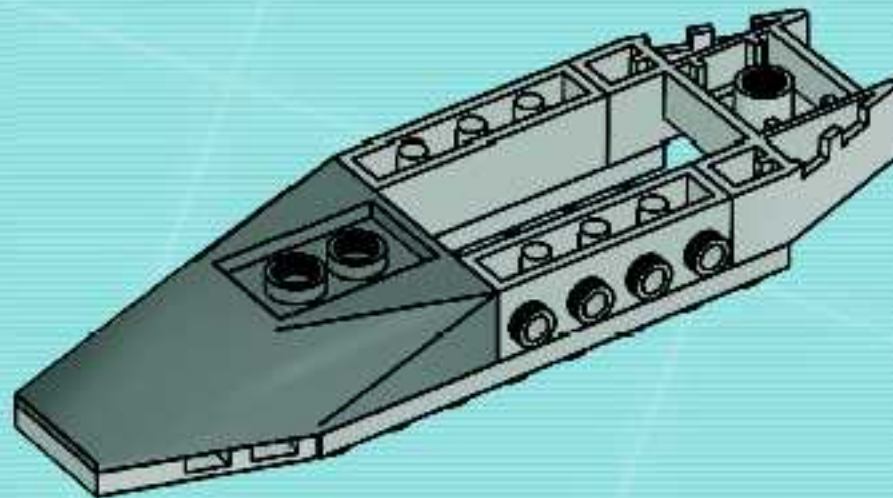

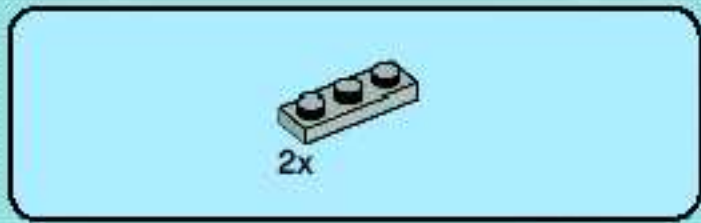

6

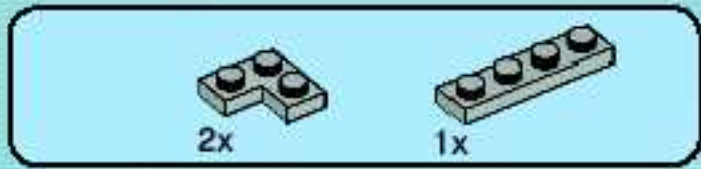
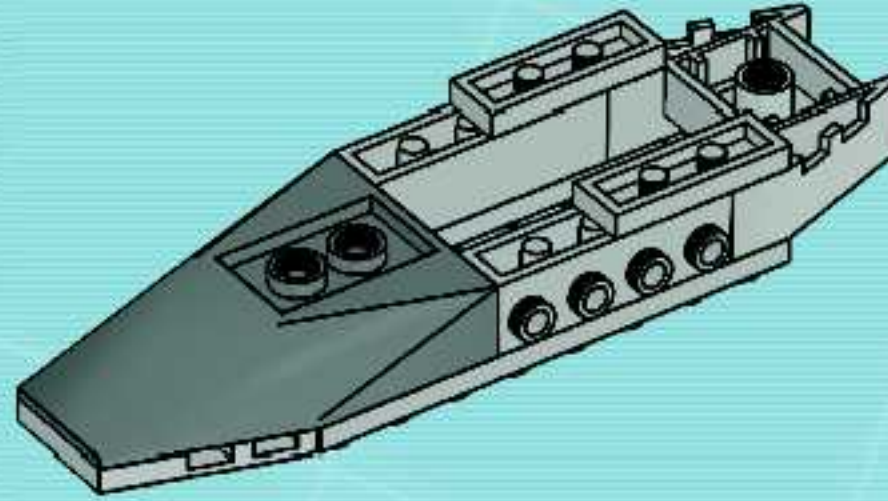

7

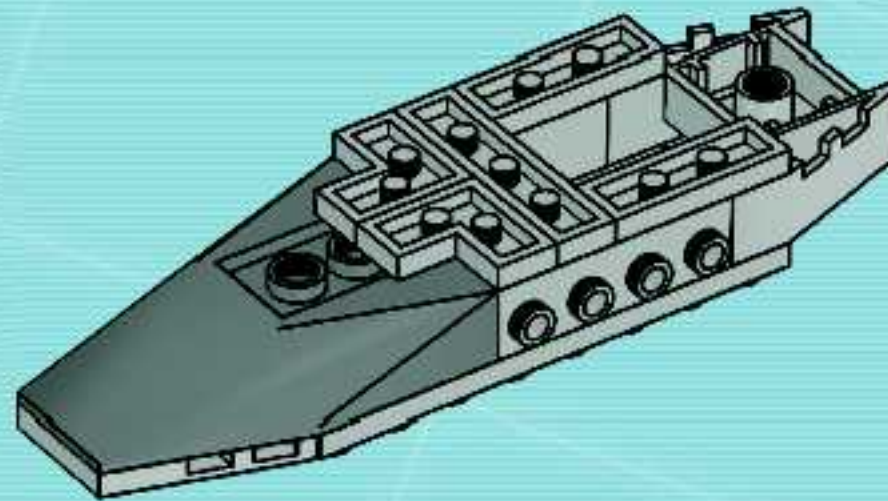



8

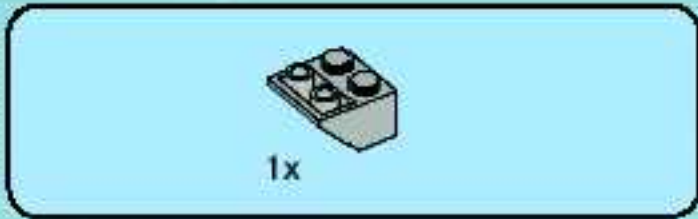
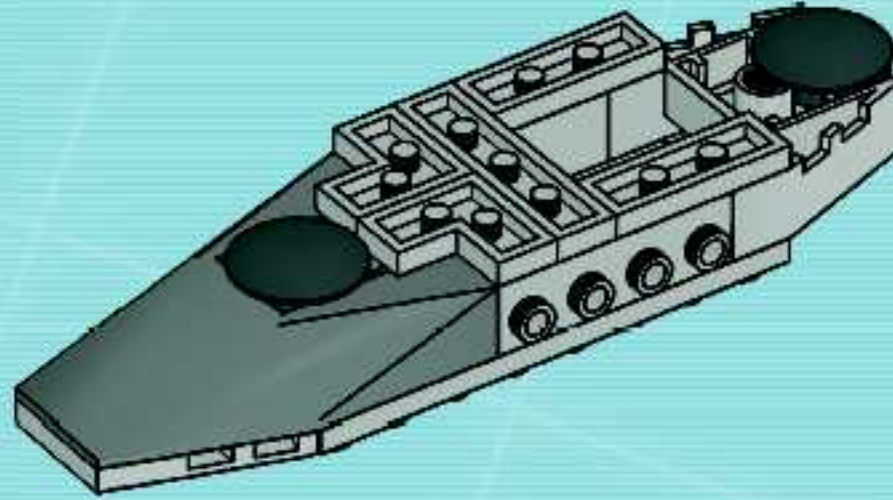

9

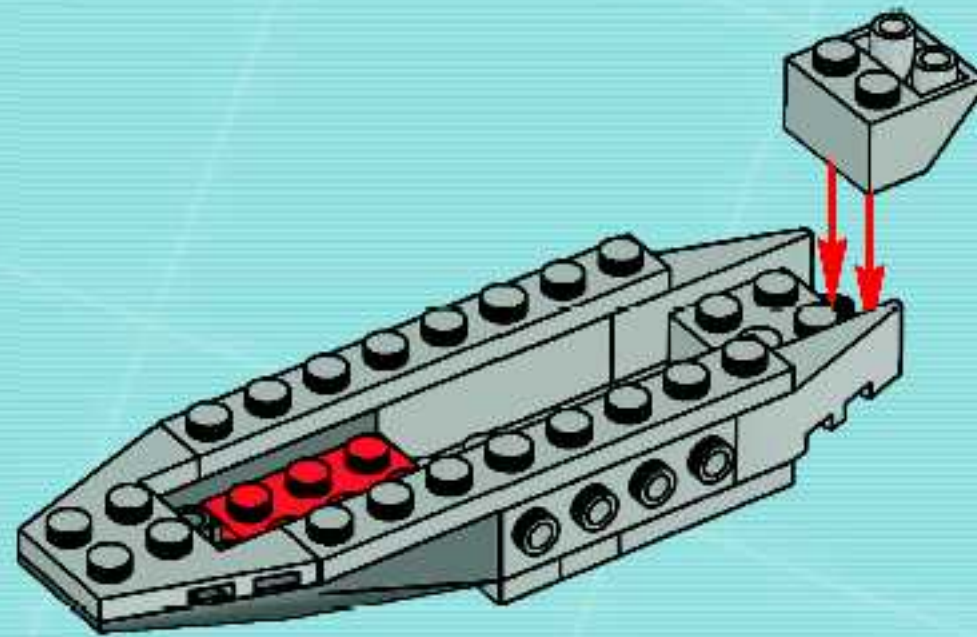

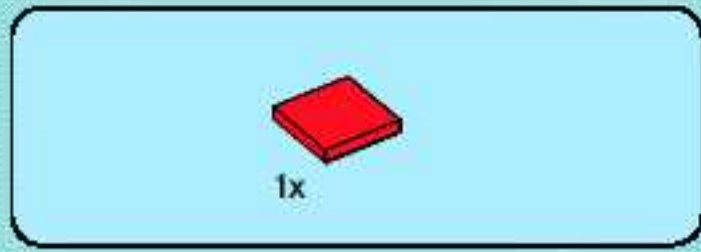

10

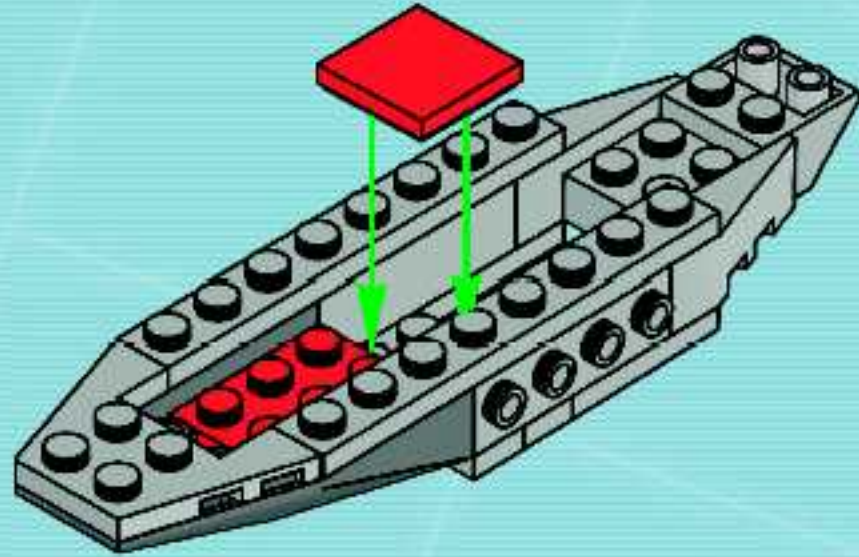

11

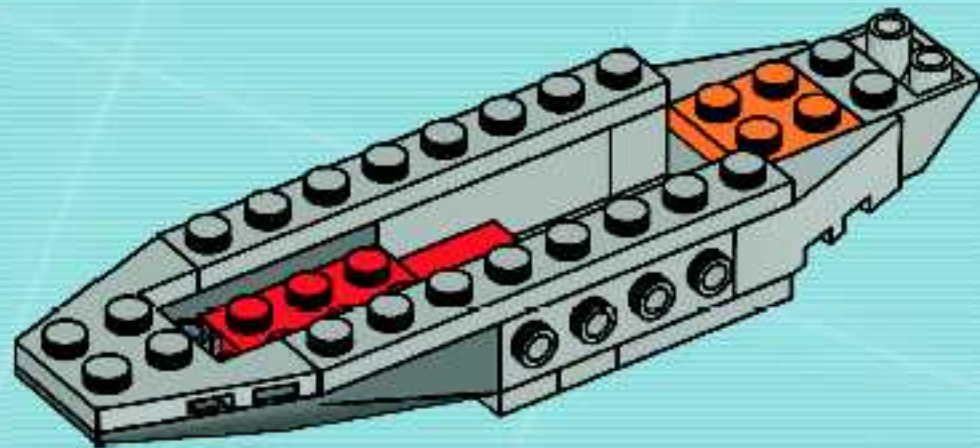

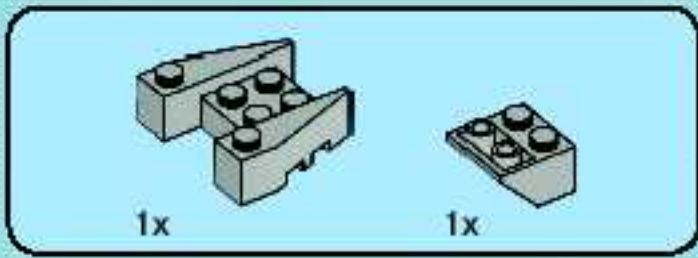

12

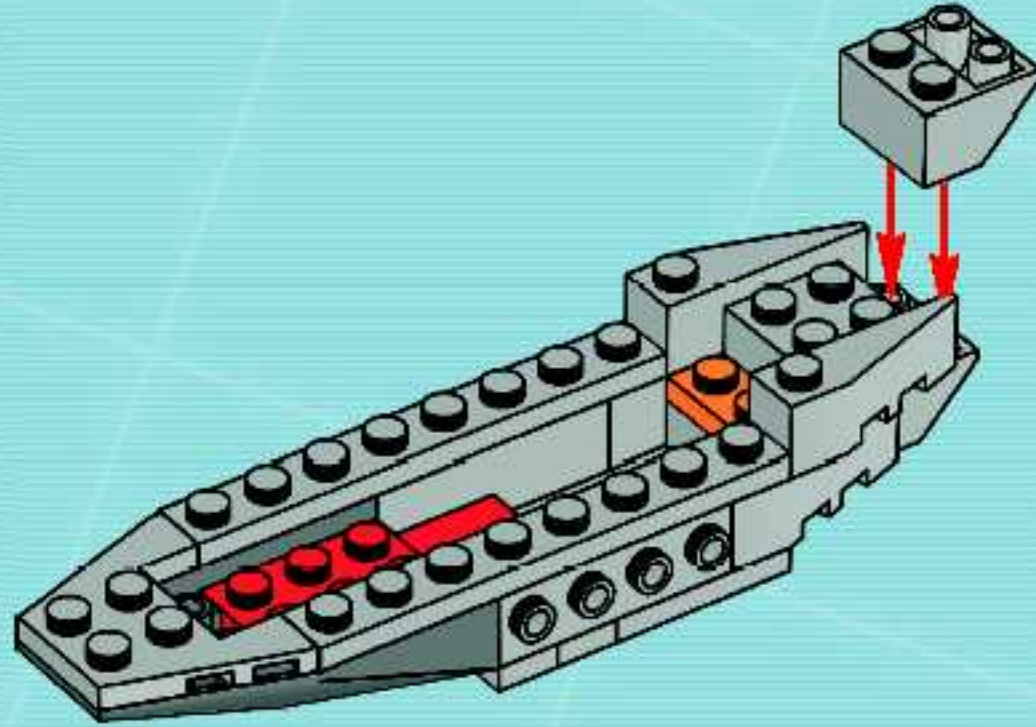

13

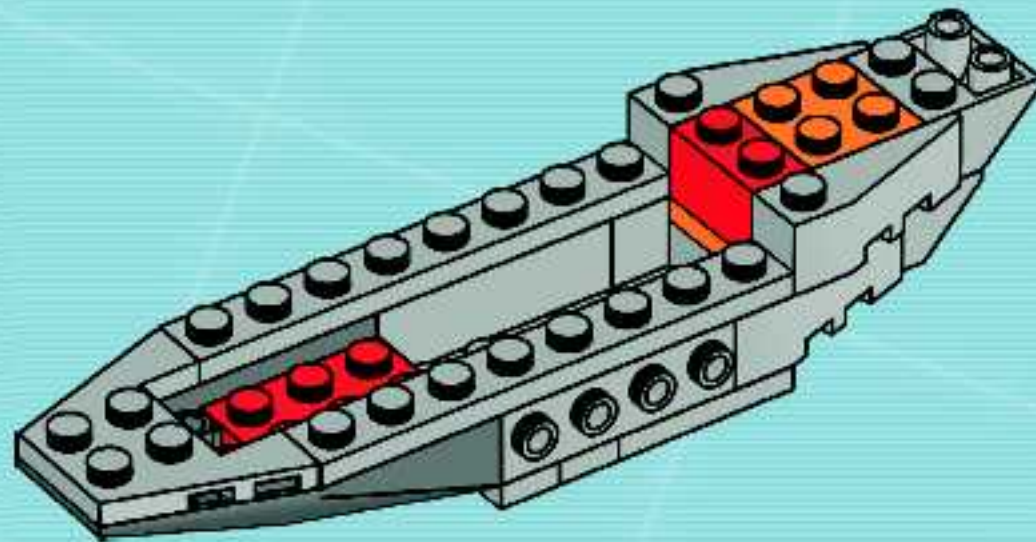



14

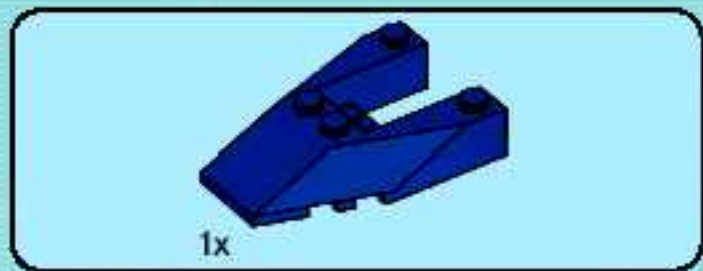
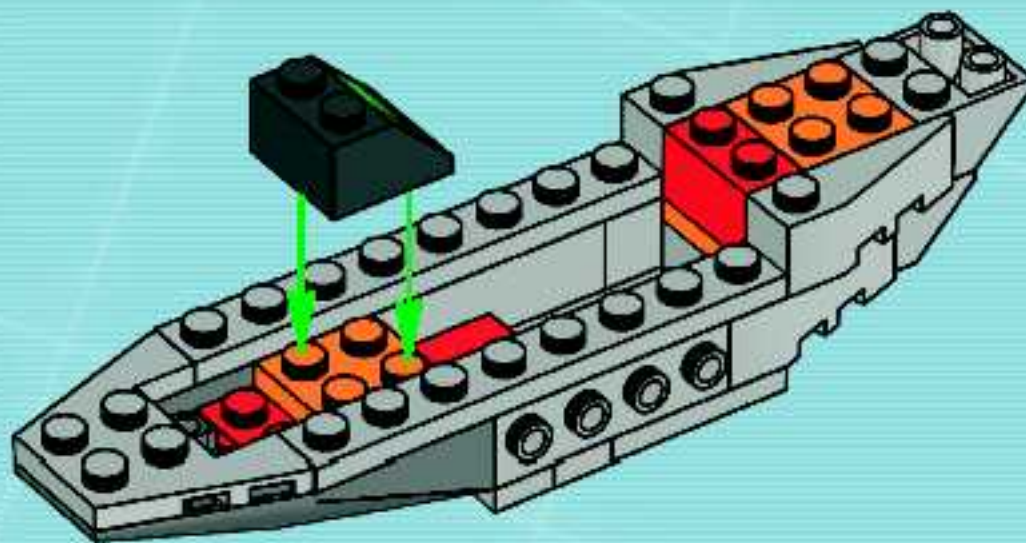

15

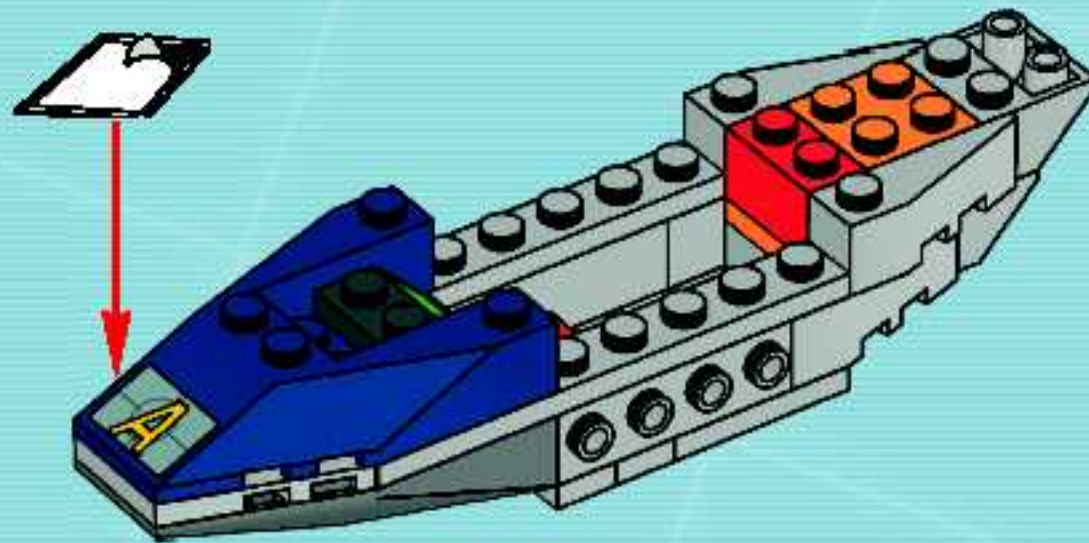



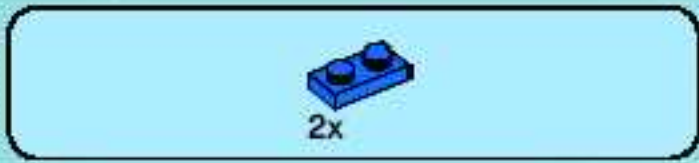

16

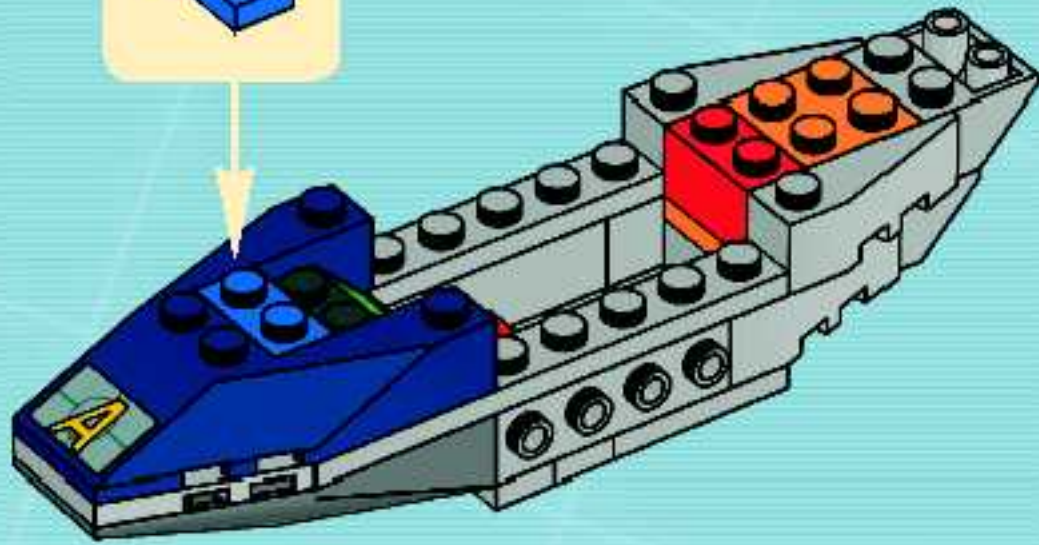
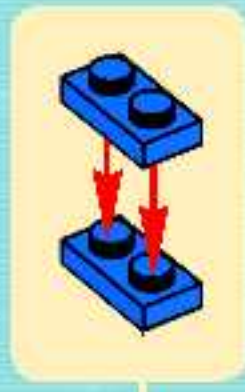

17

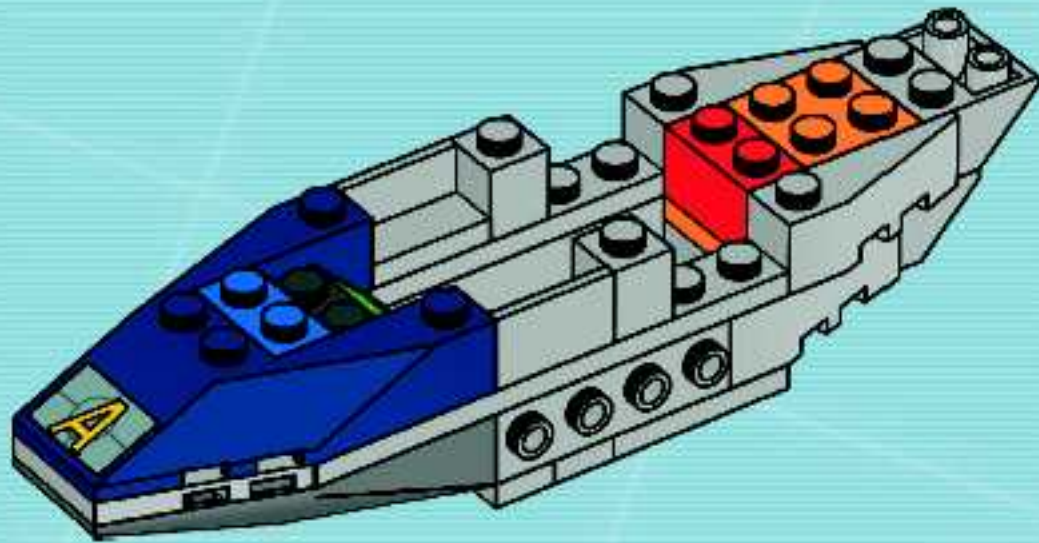



2x

# 18

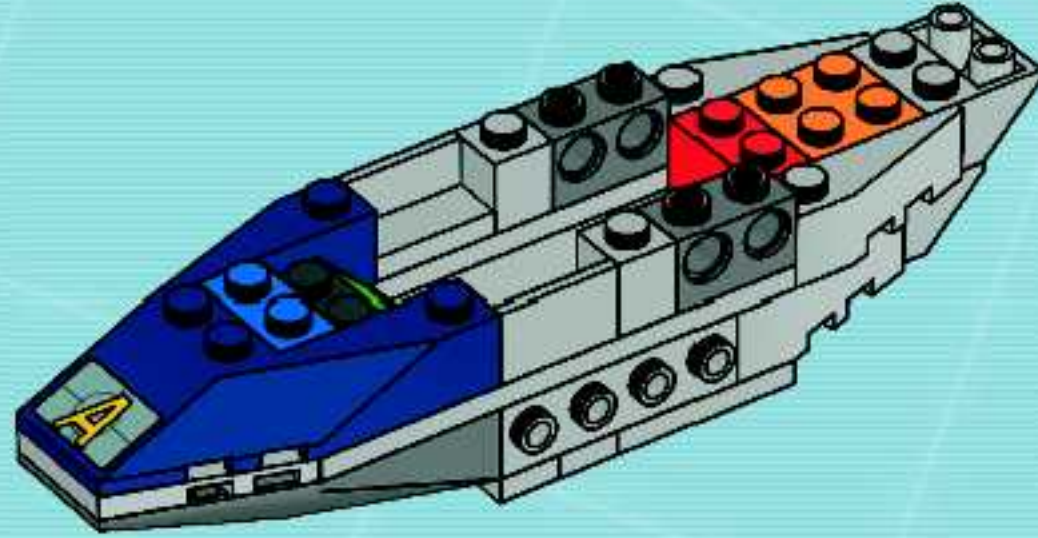

2x

# 19

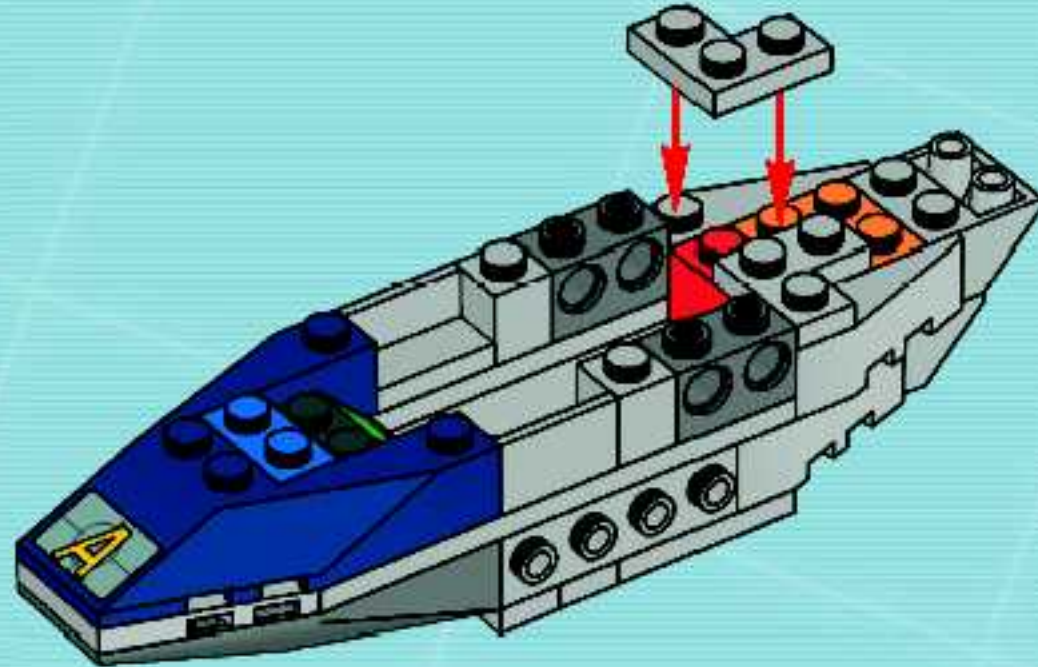



20

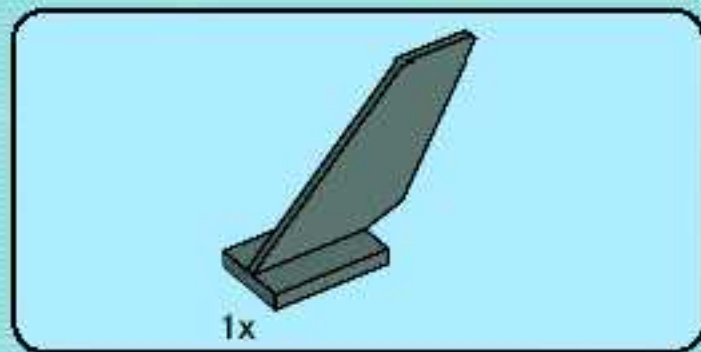
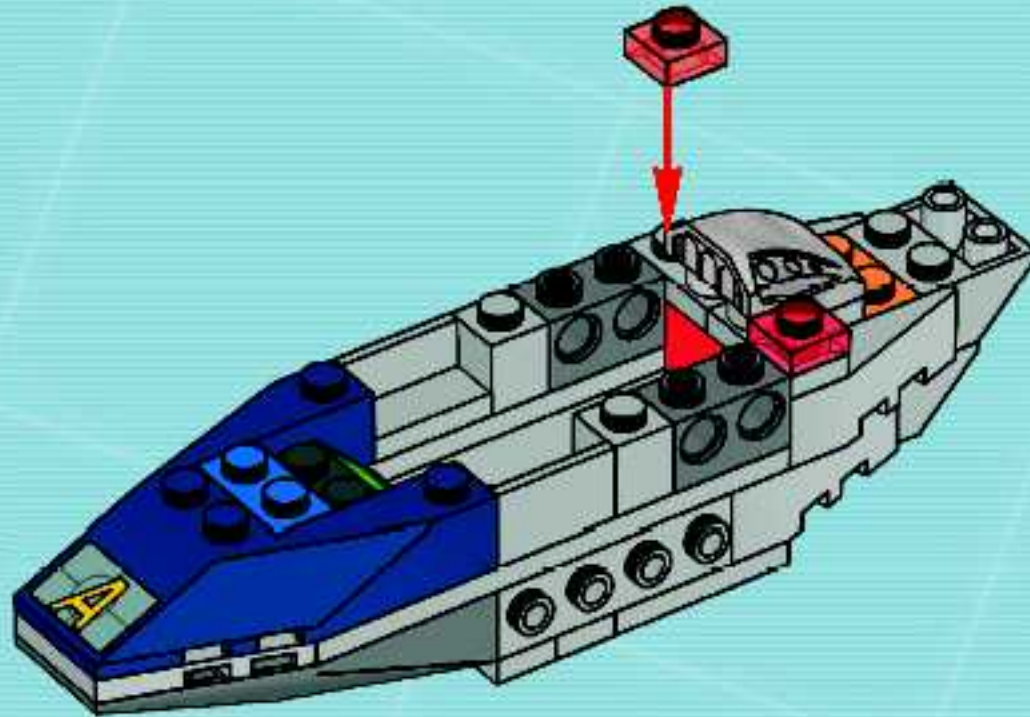

21

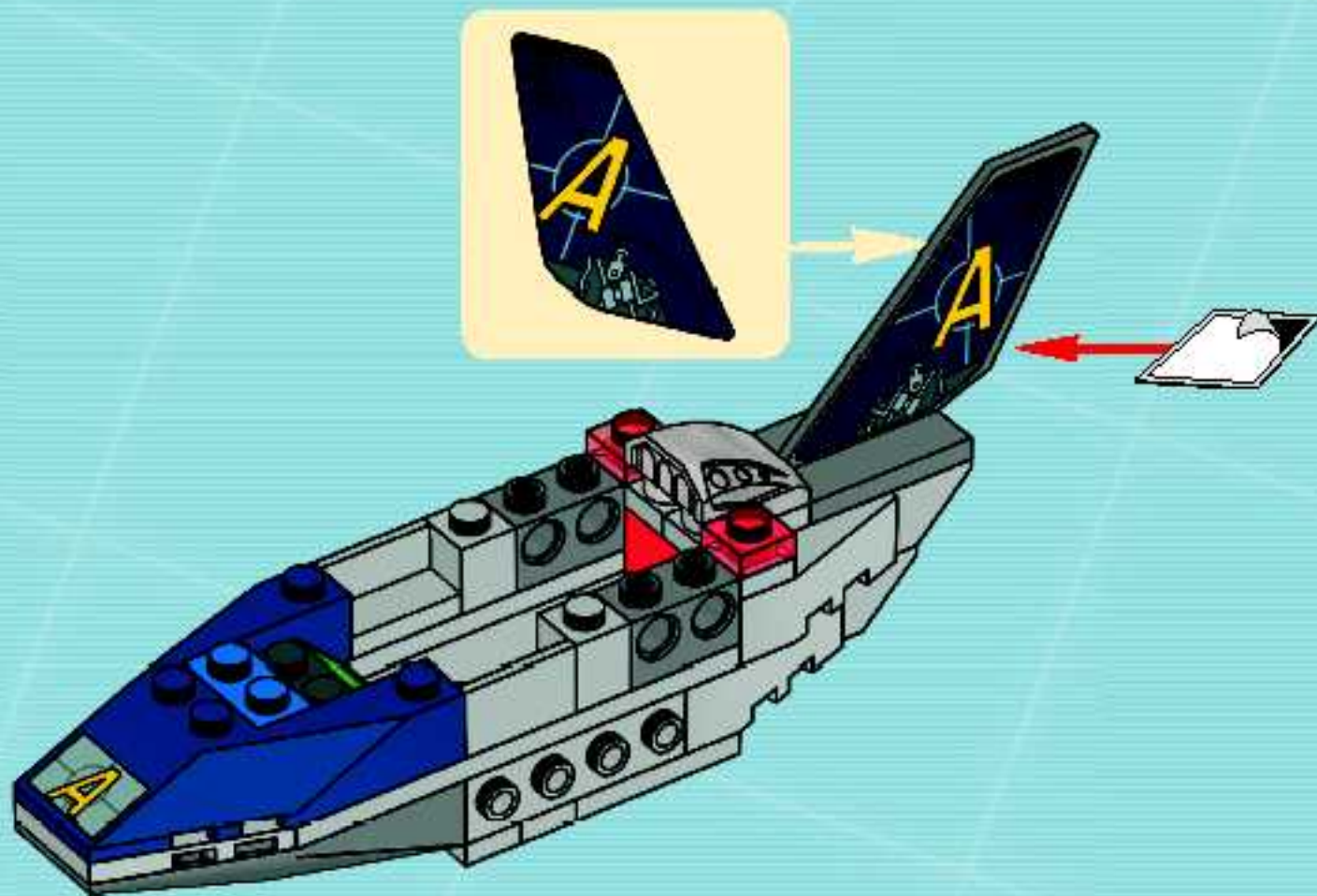

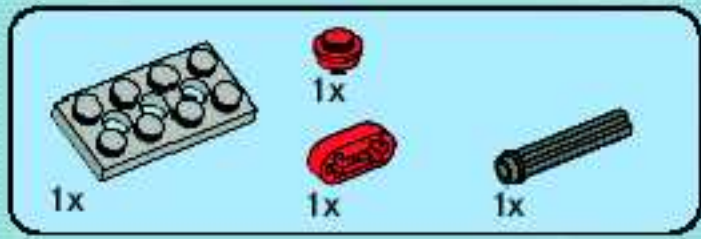

22

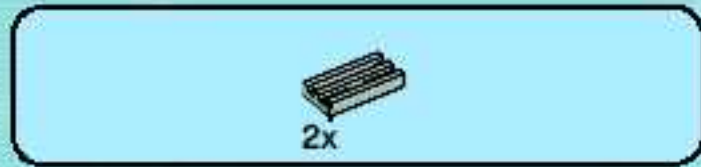
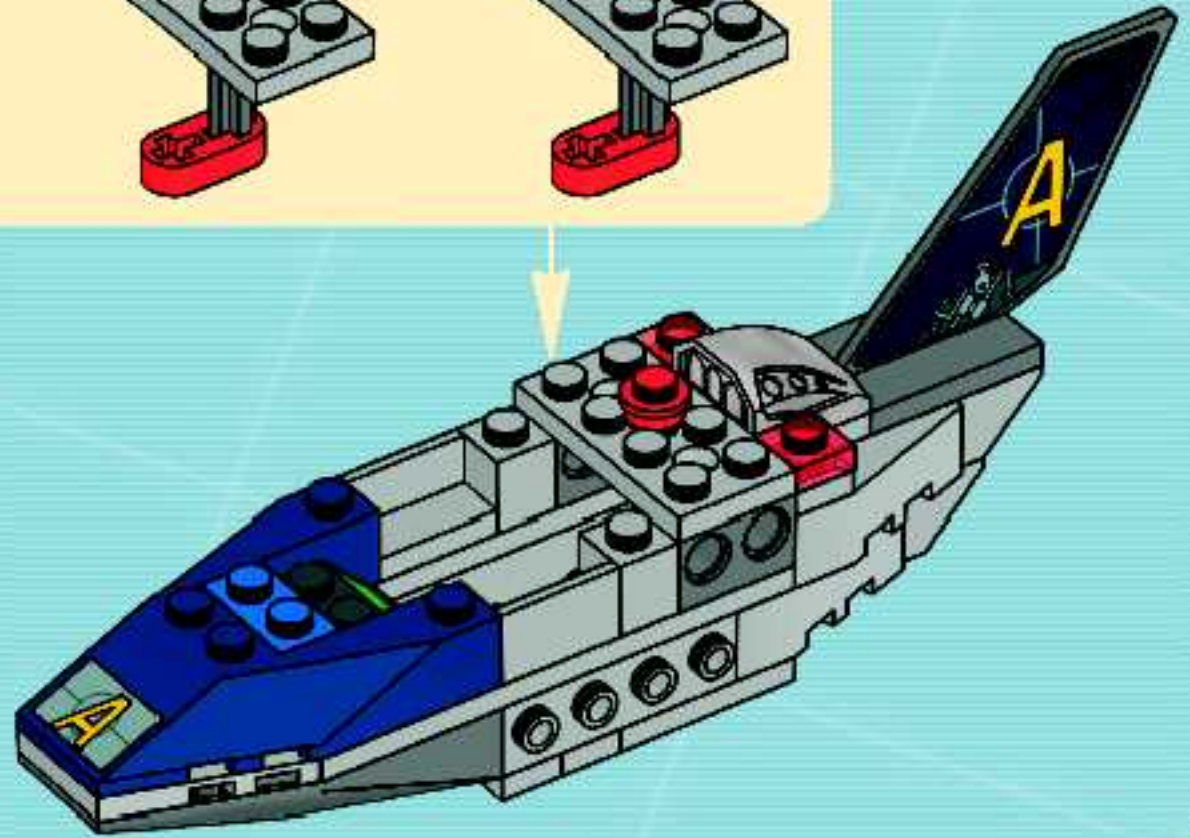
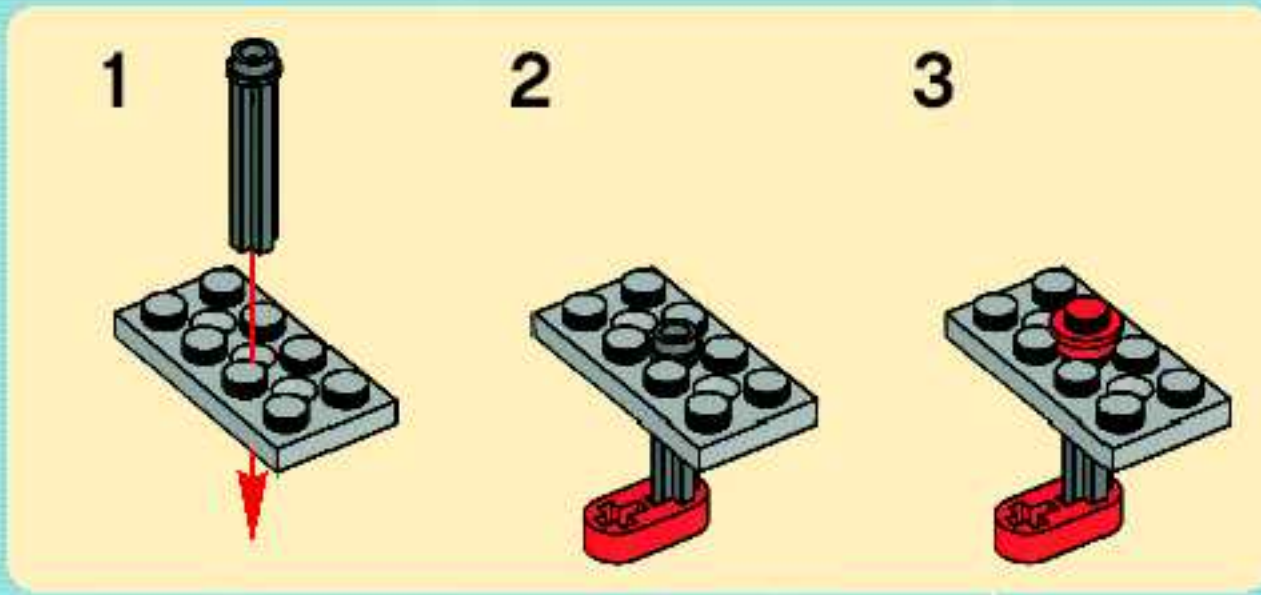

23

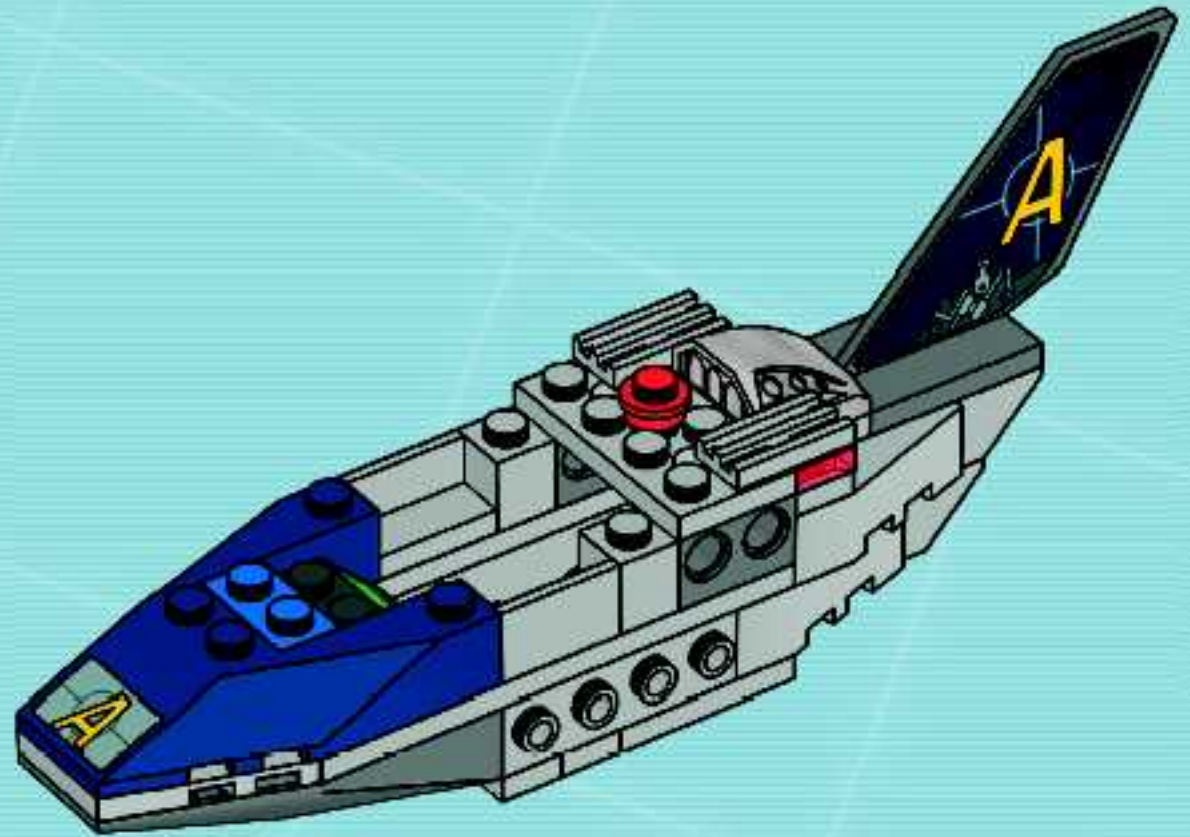

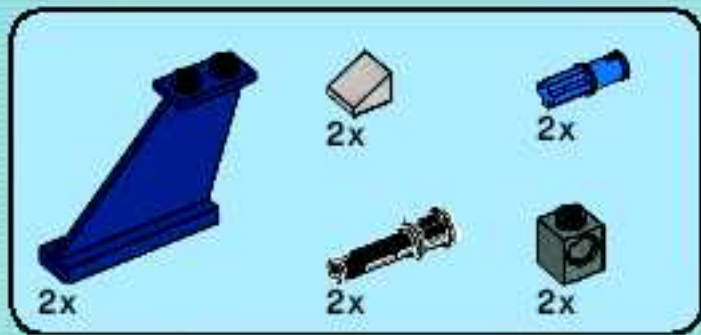

24

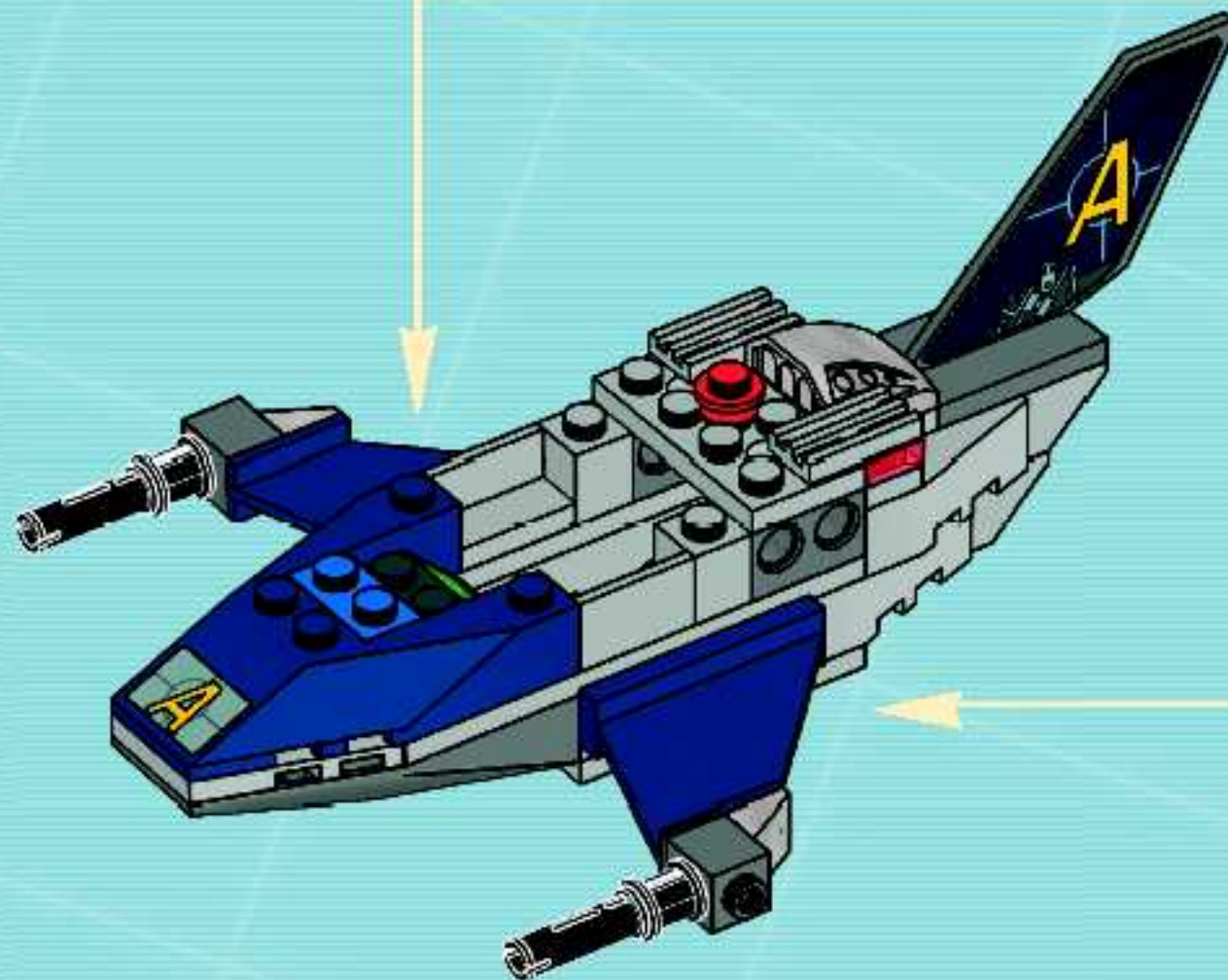
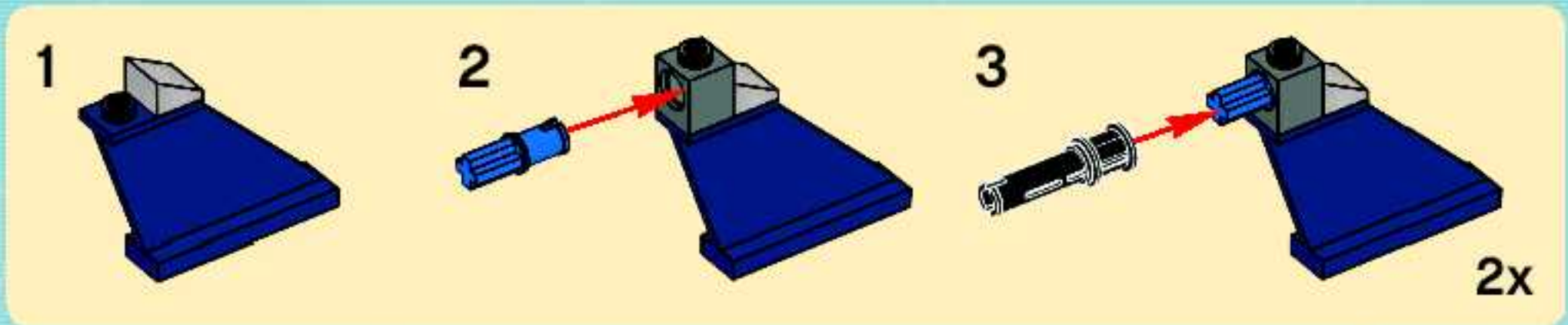

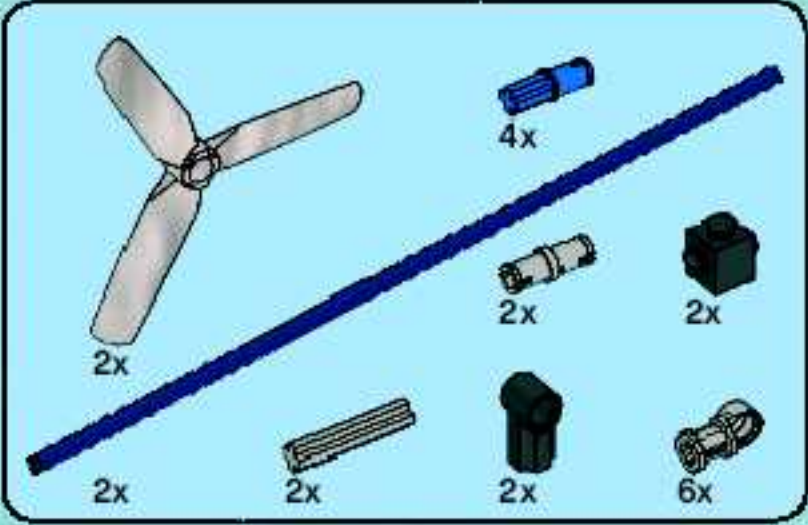

25

1



2

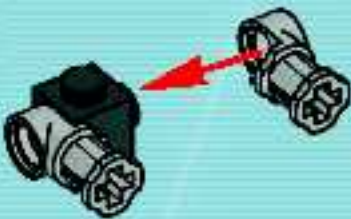

3



4

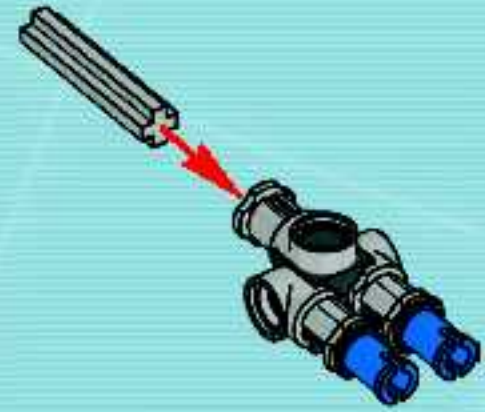

5

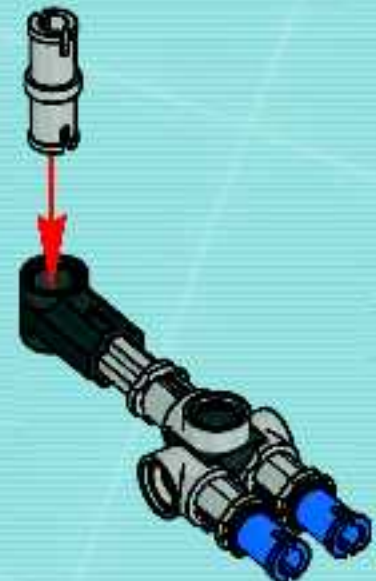

6

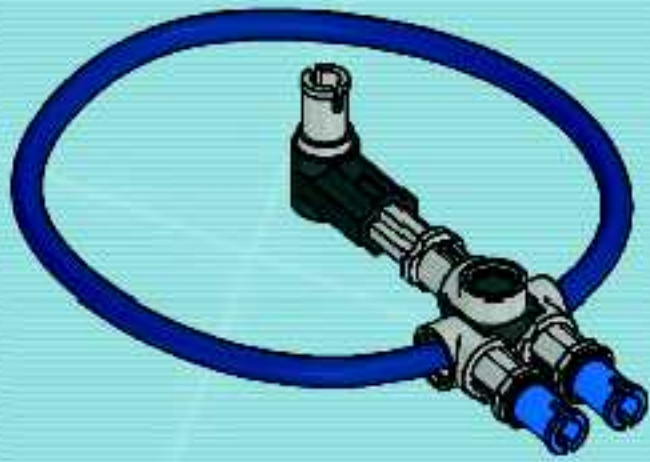

7

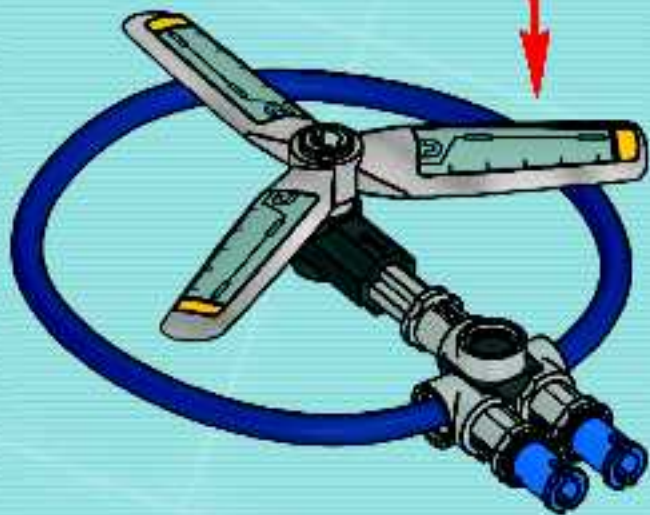

2x

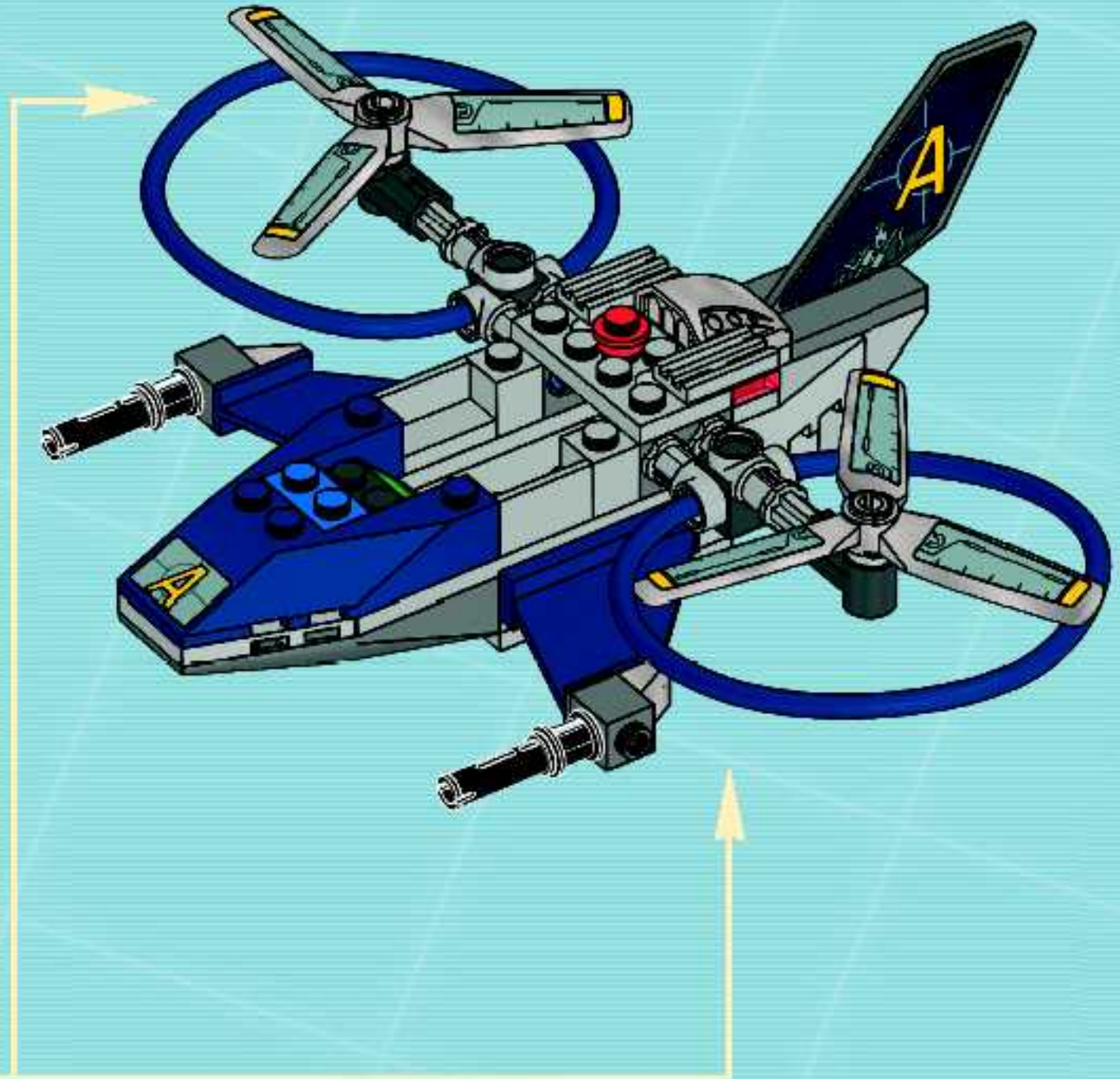

26

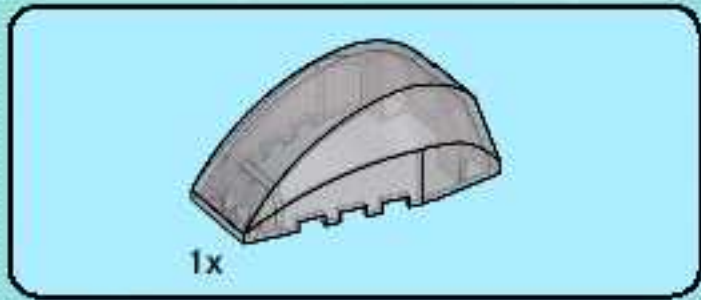

27

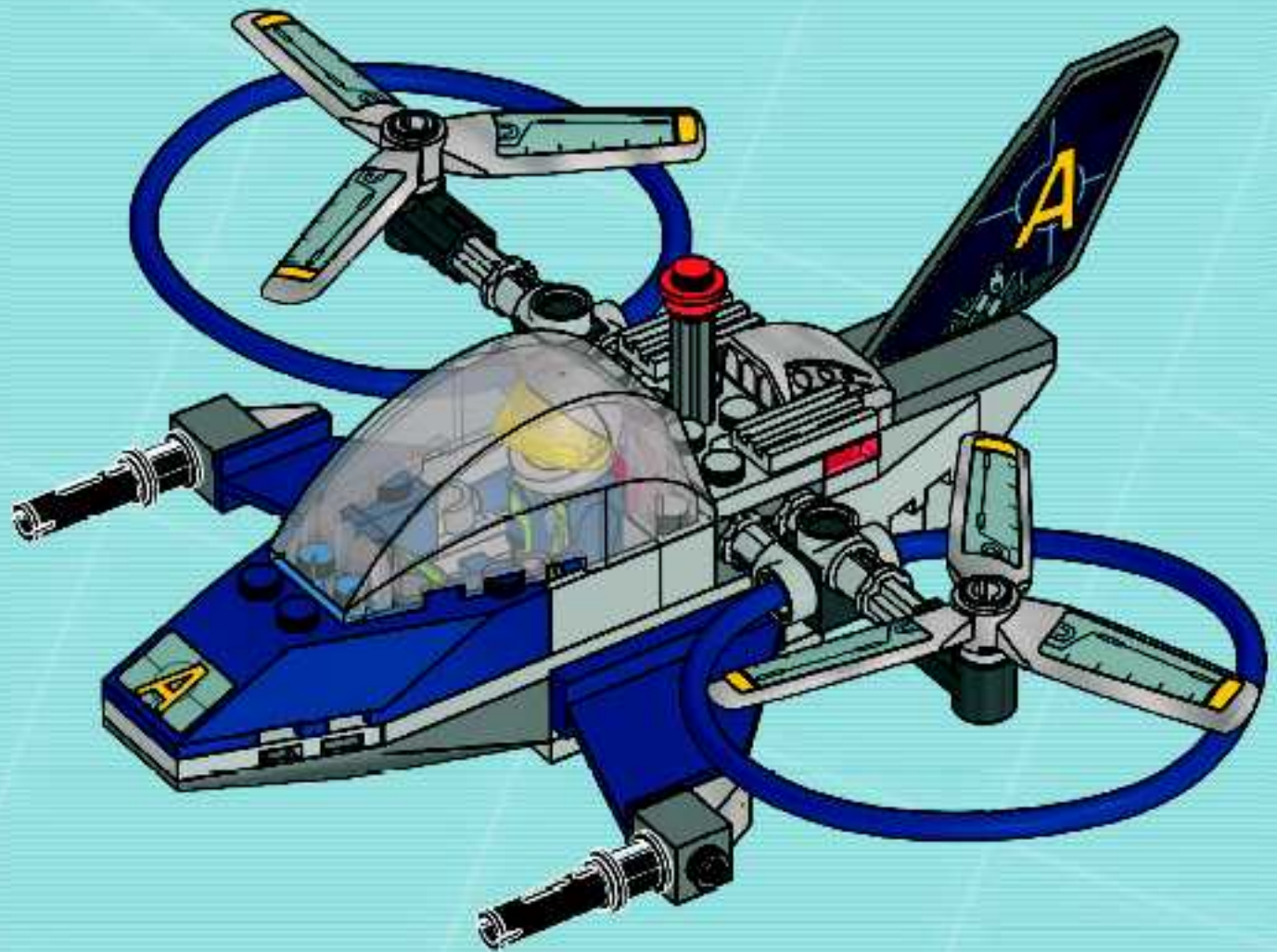



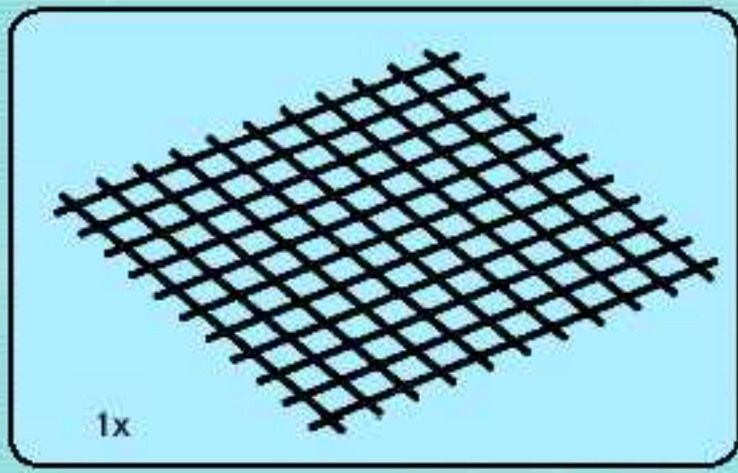

28

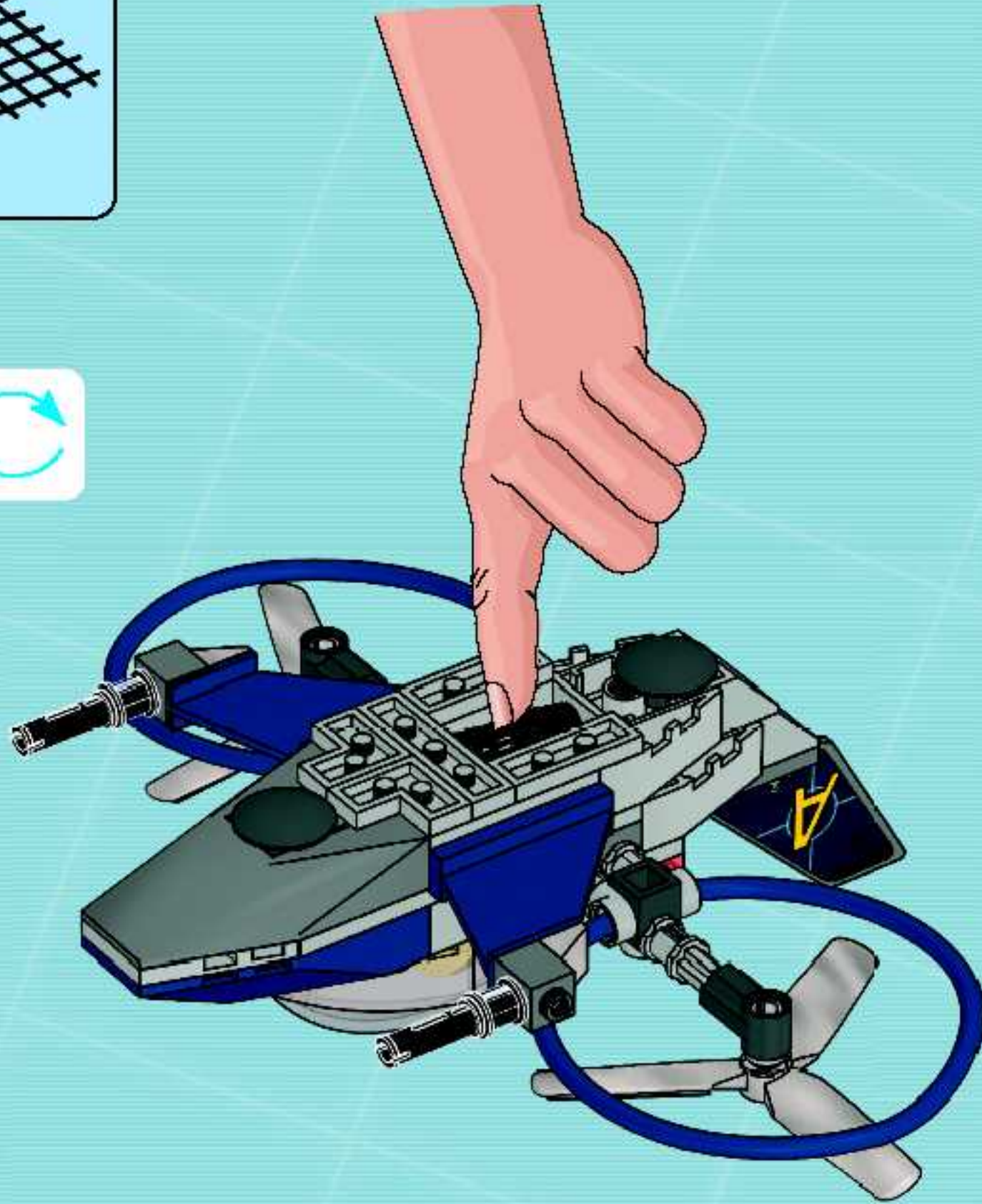

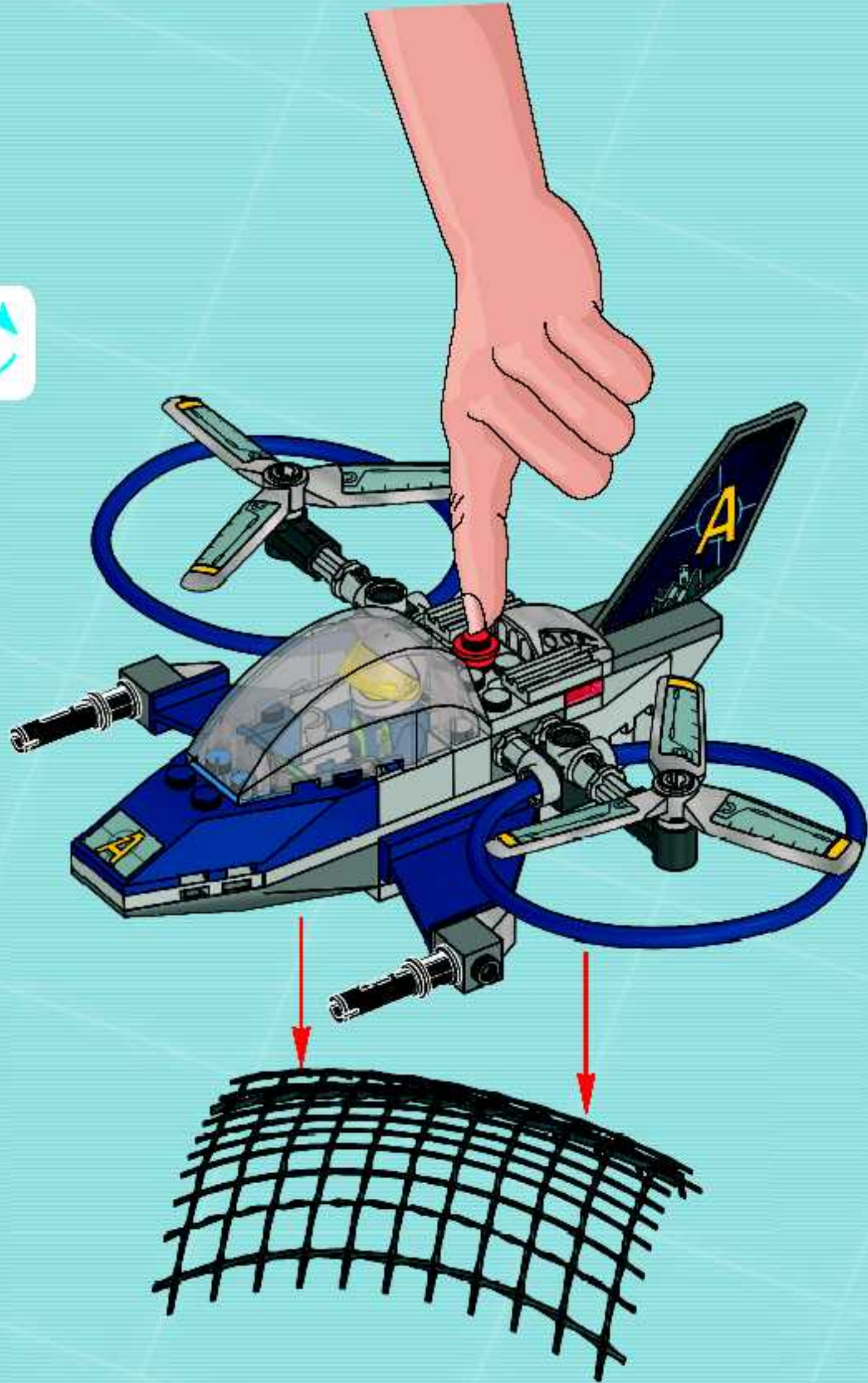

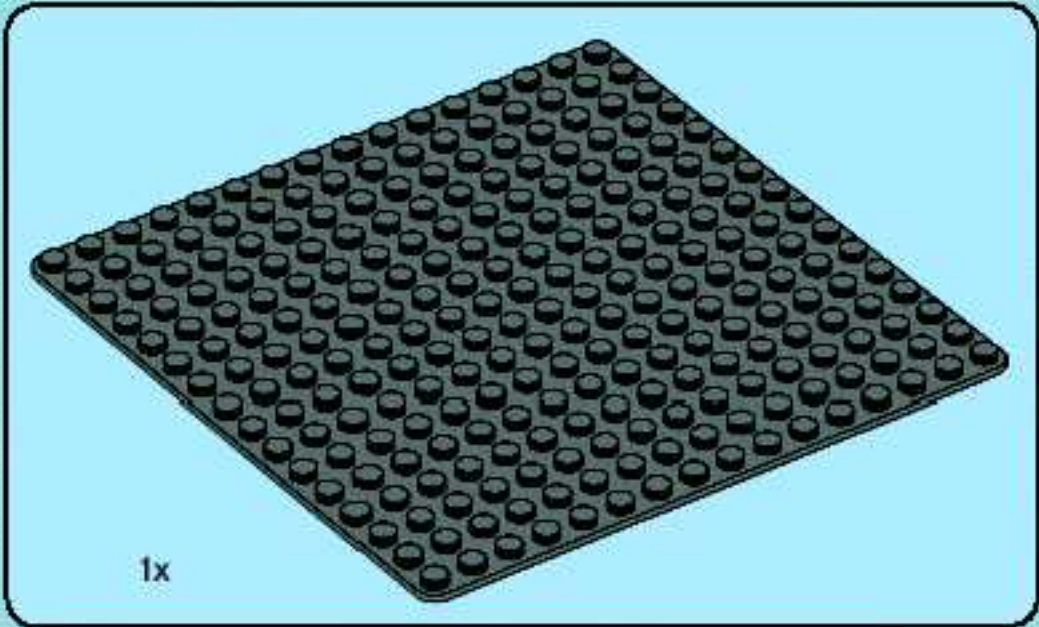
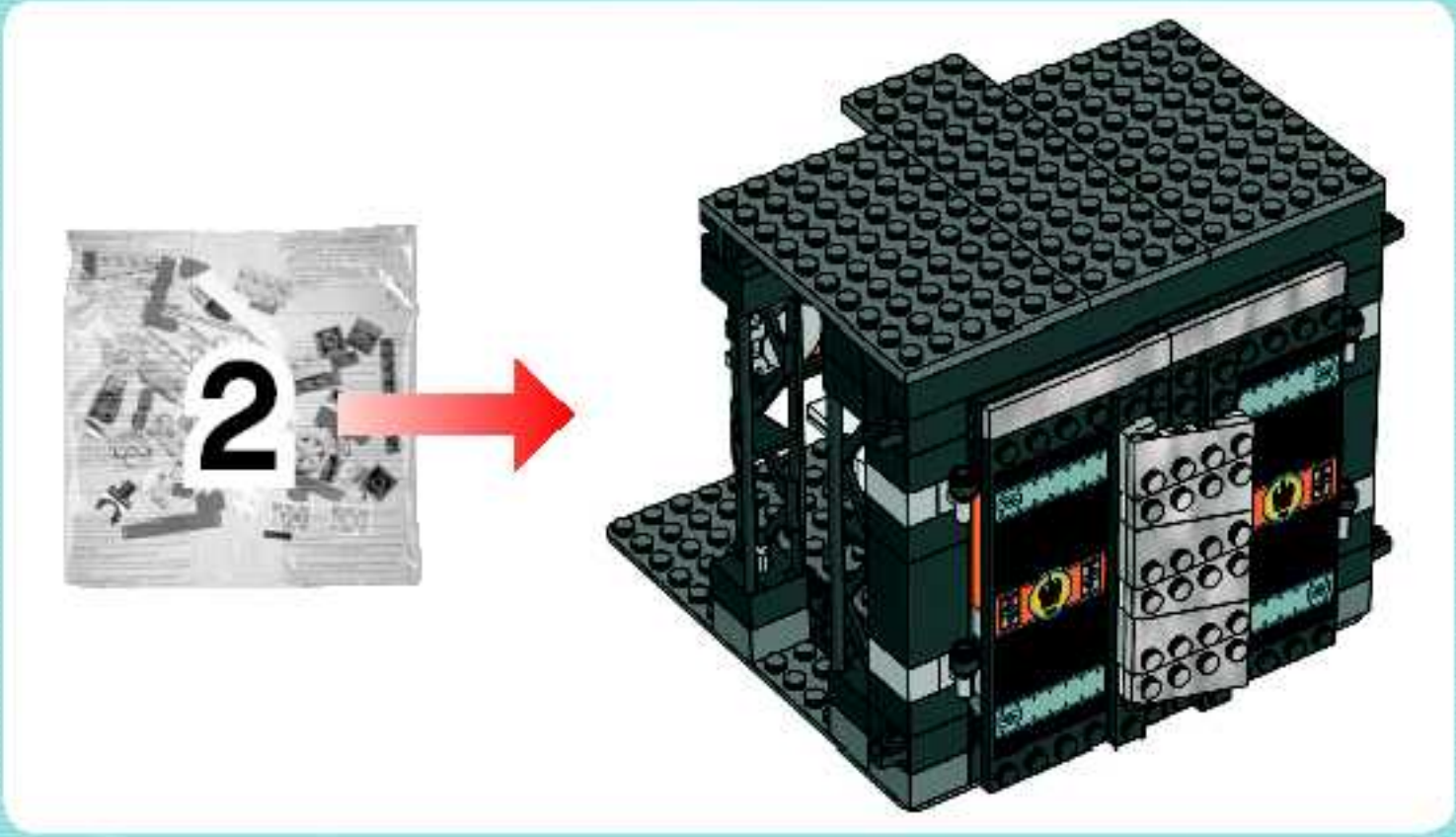

1

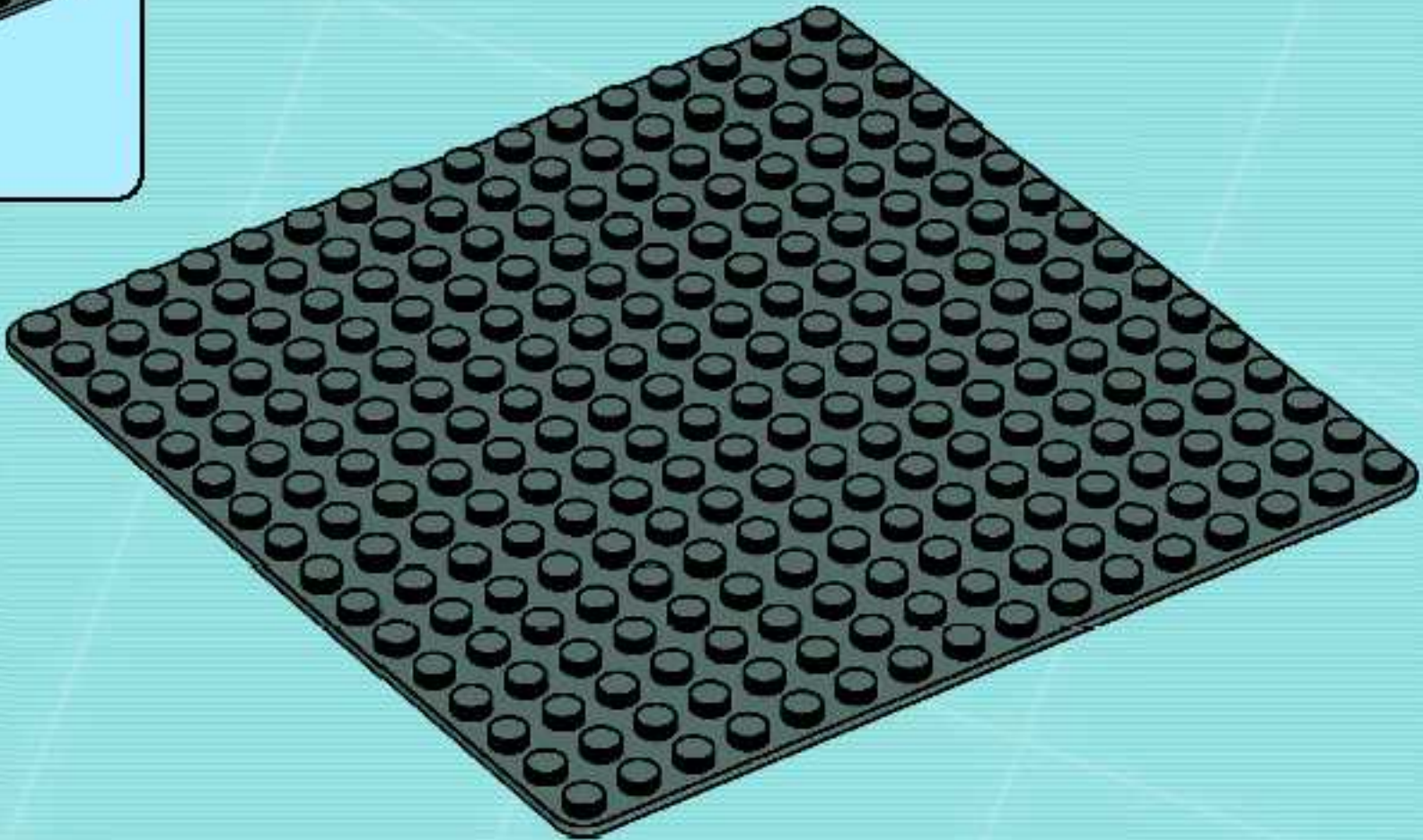

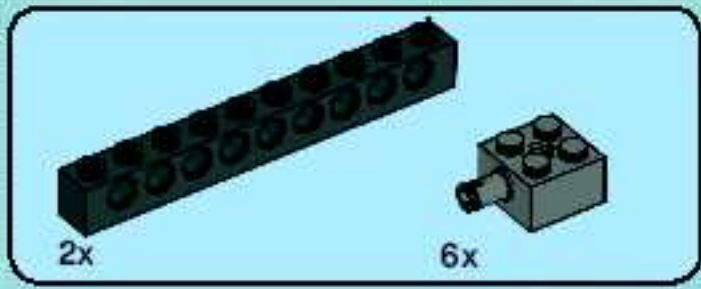

2

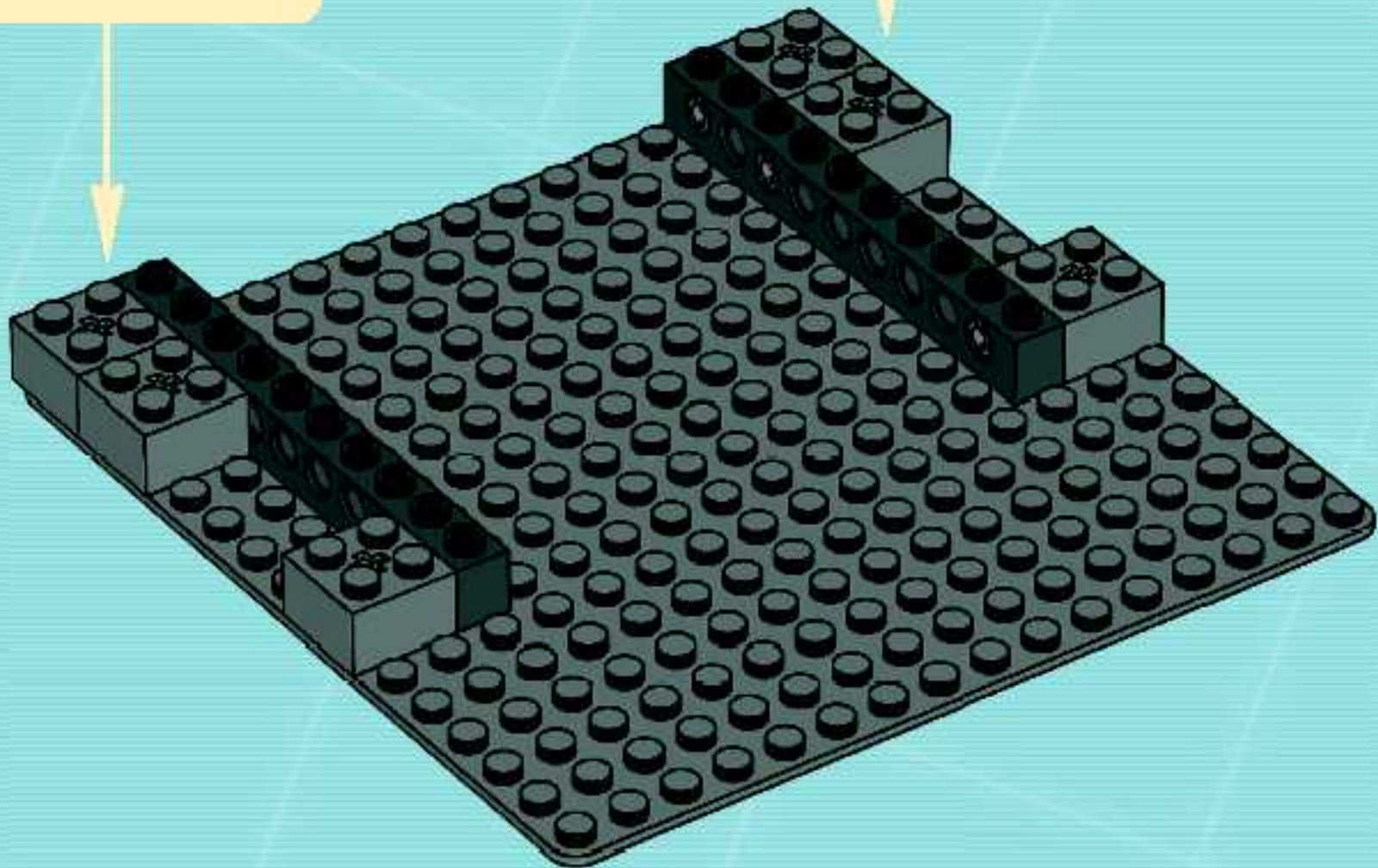
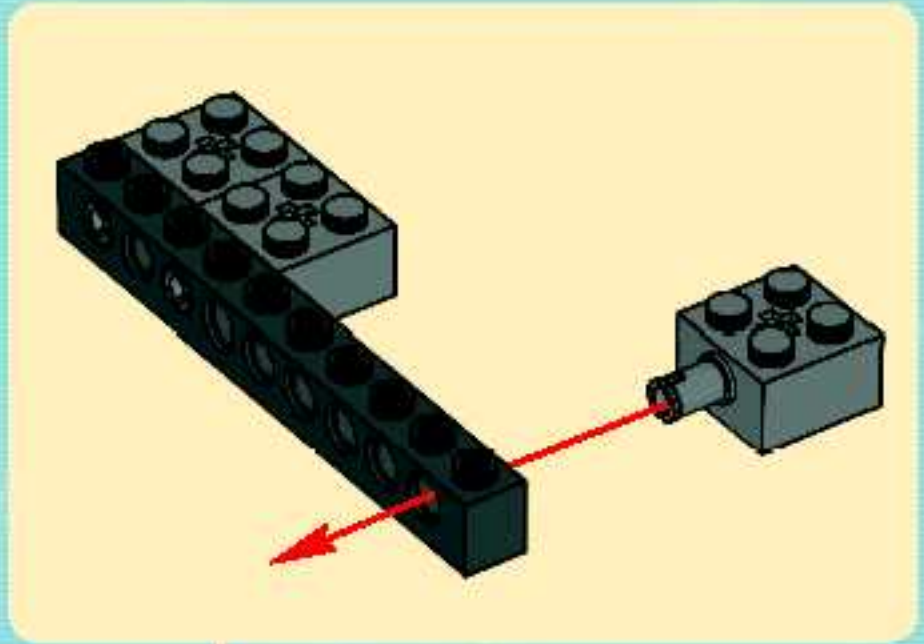
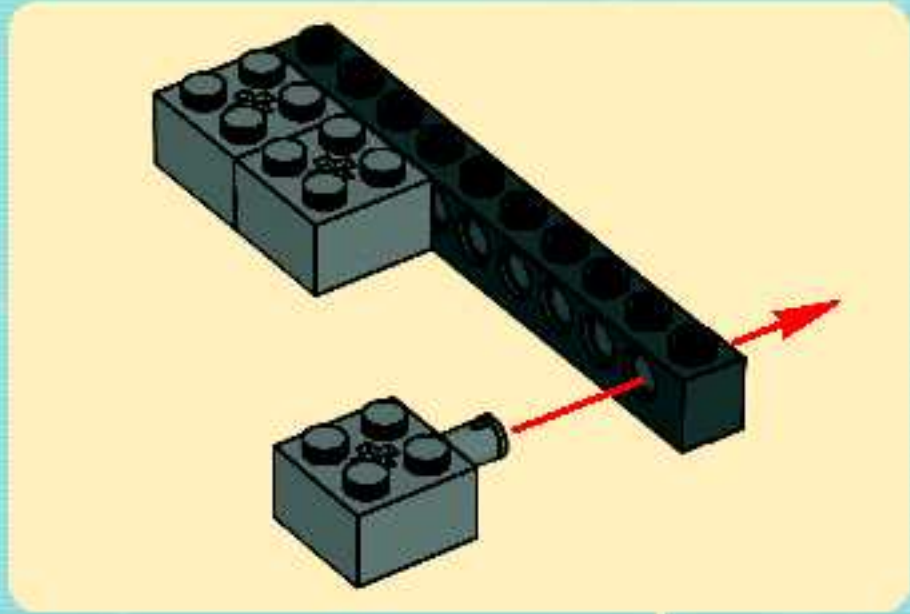

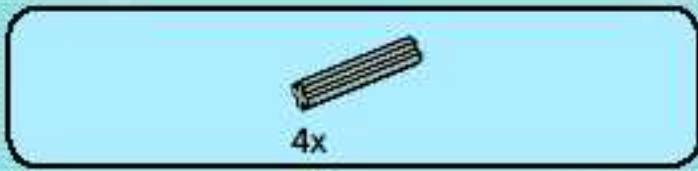

3

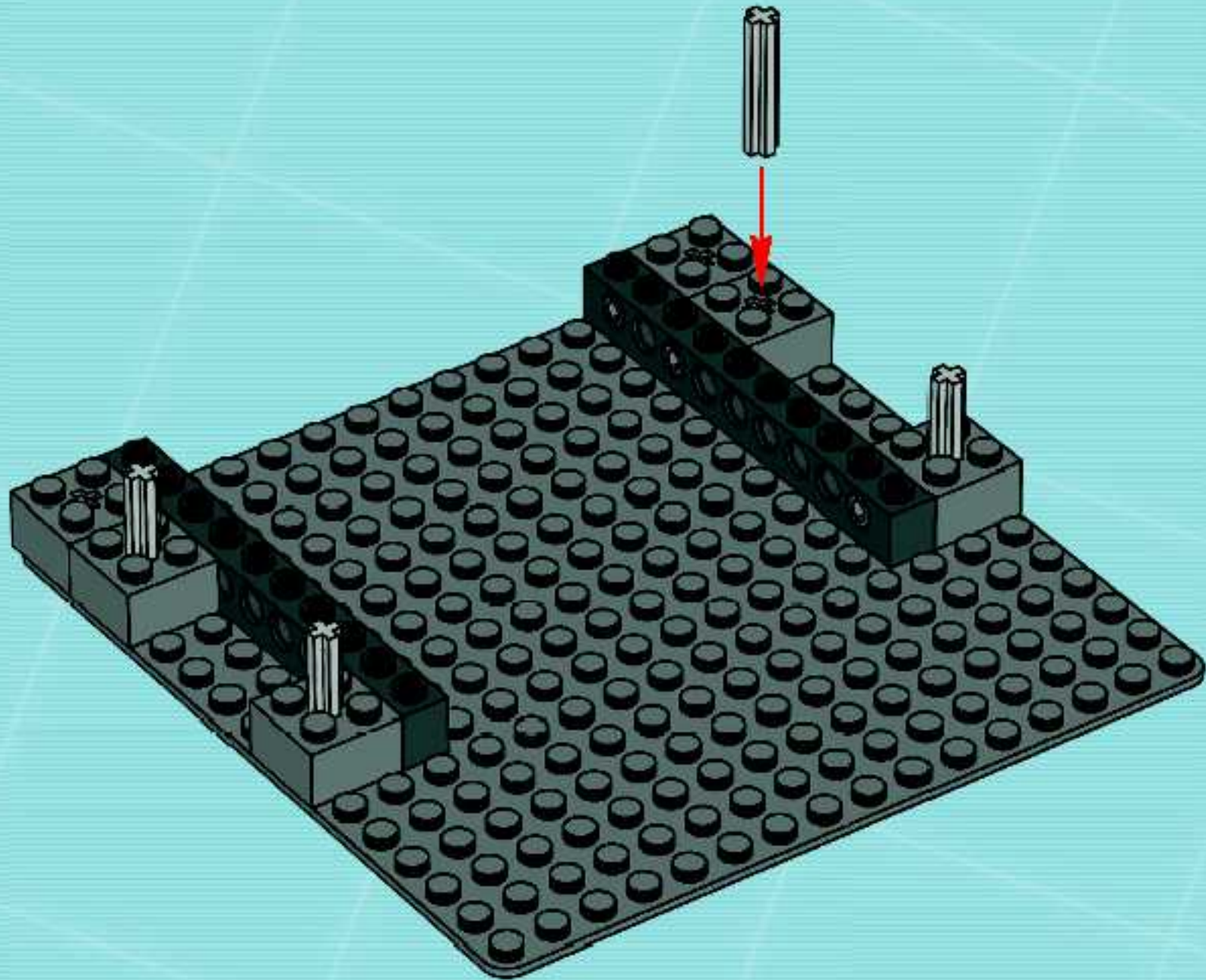

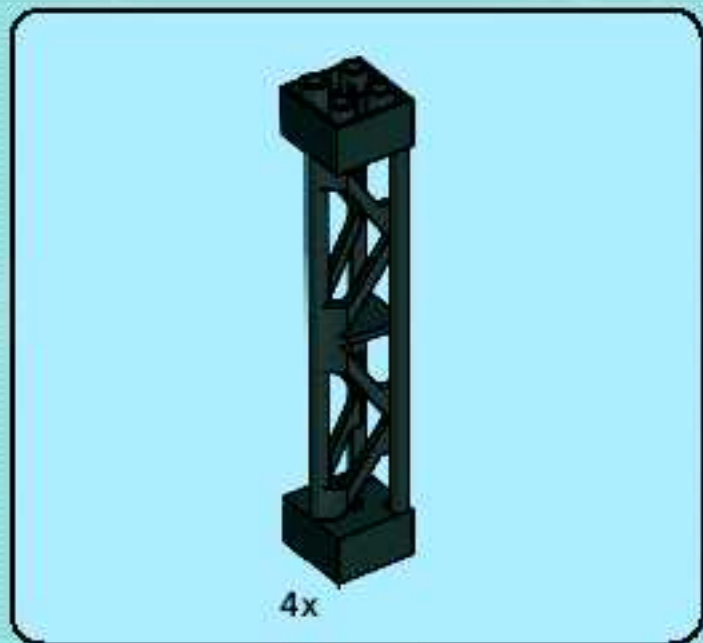

4

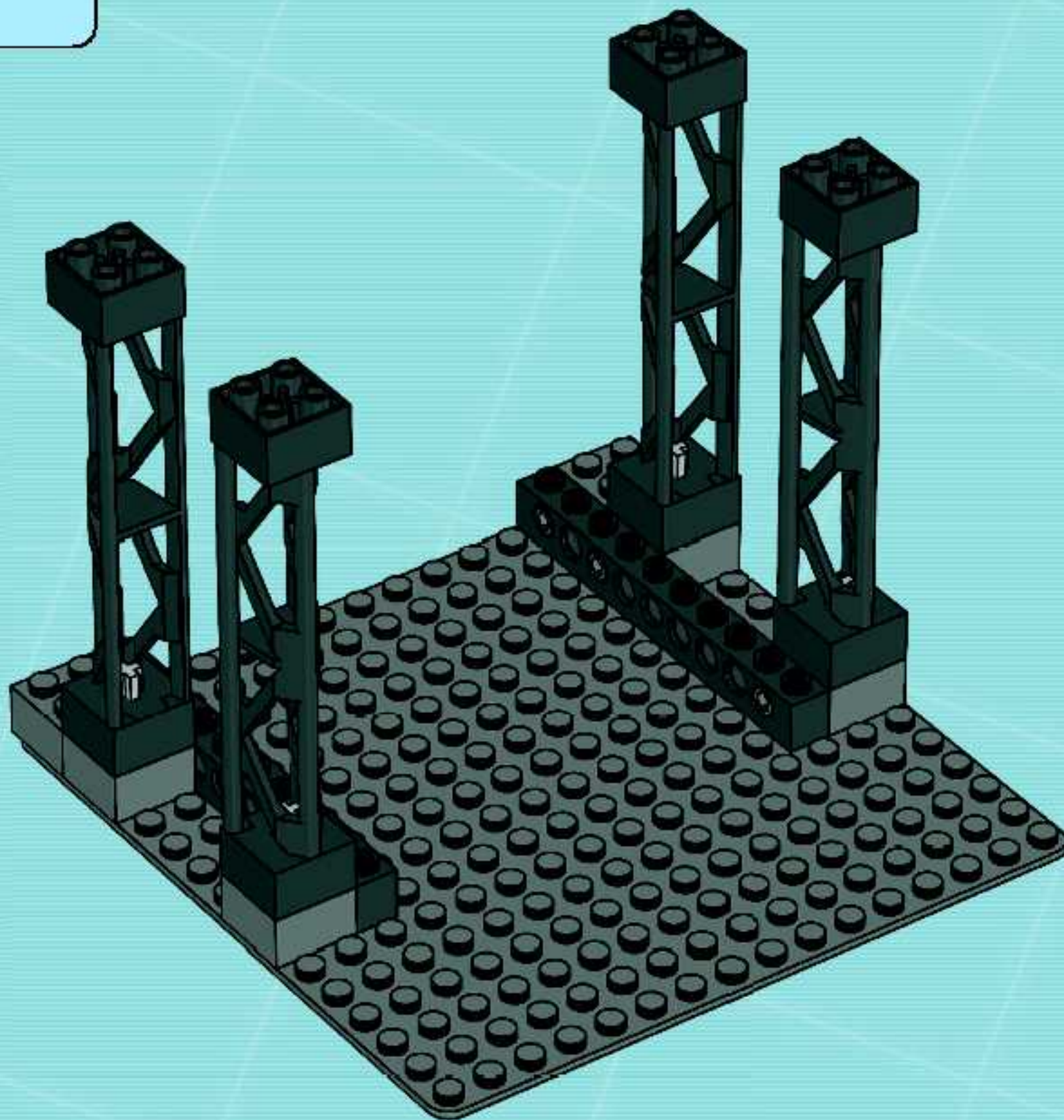

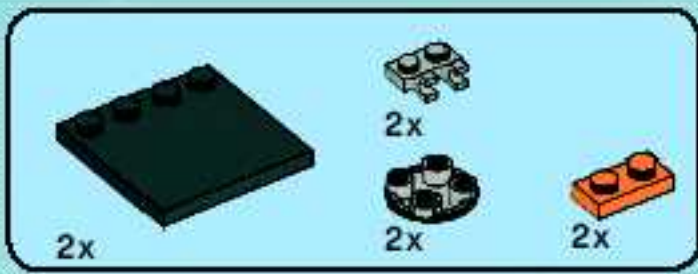

5

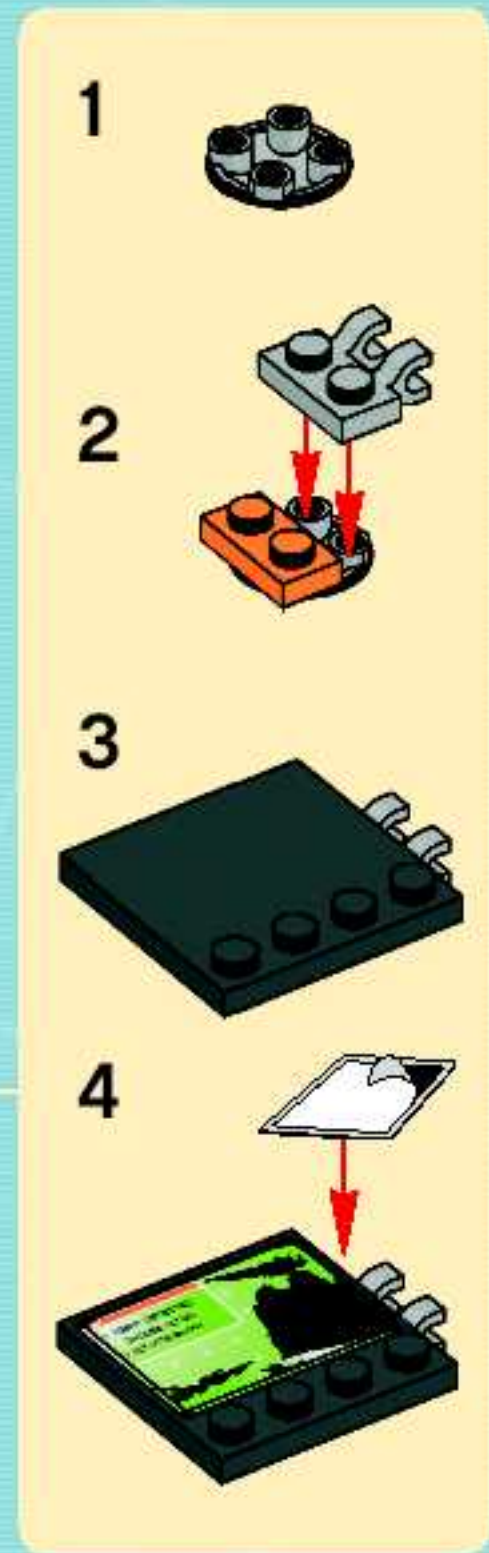
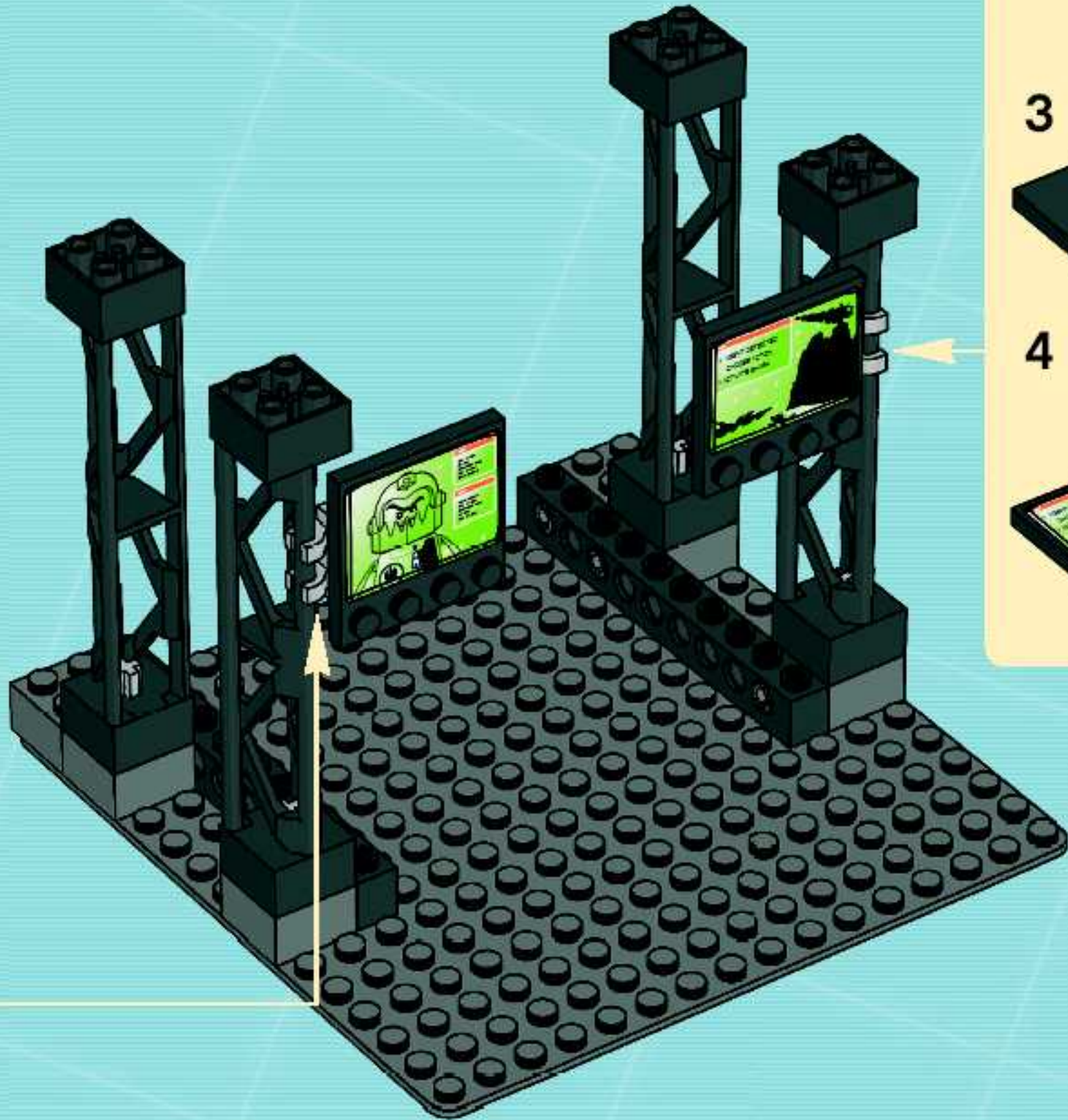
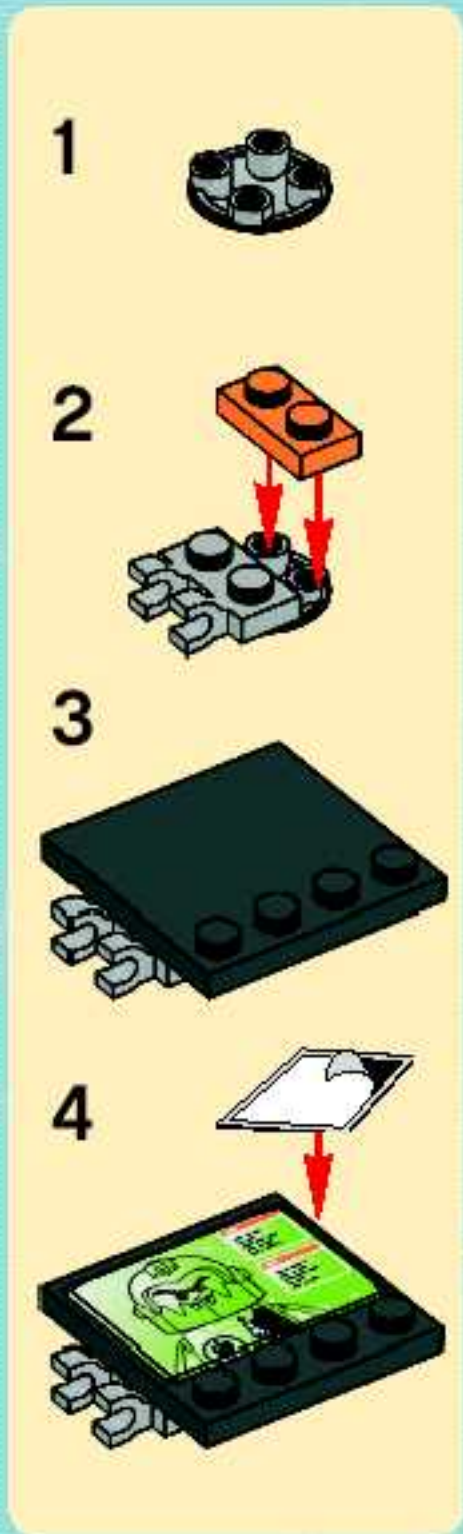

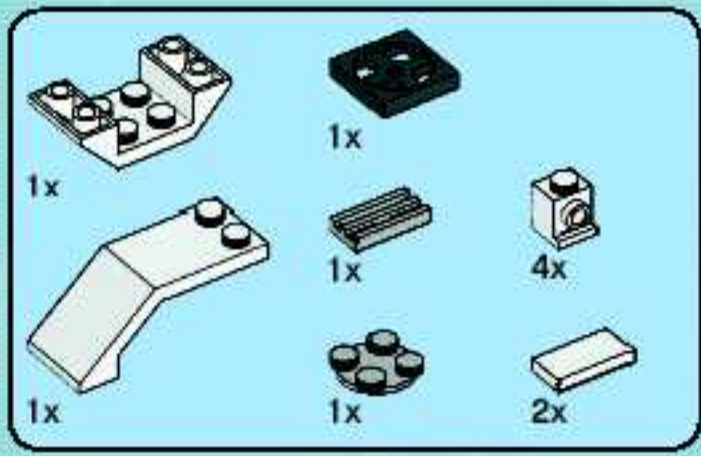

6

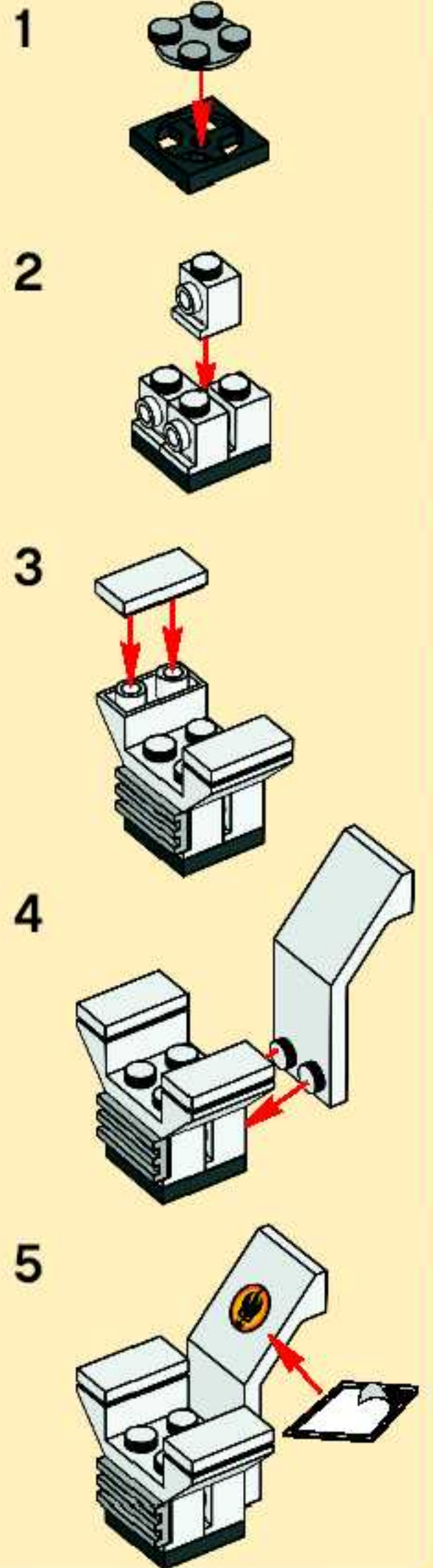
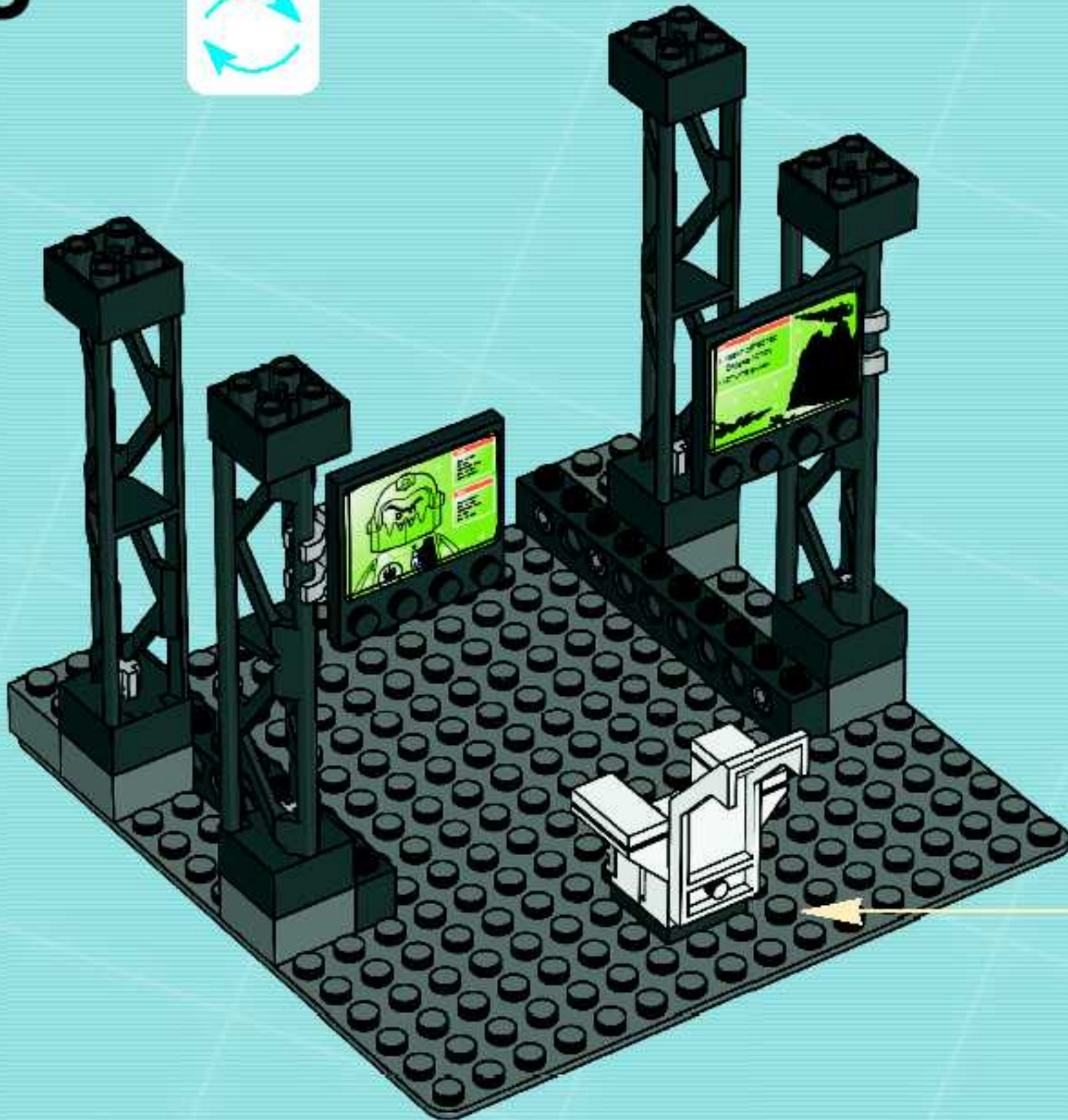



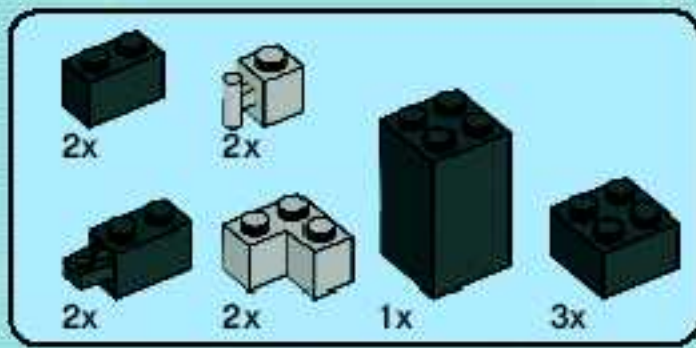

7

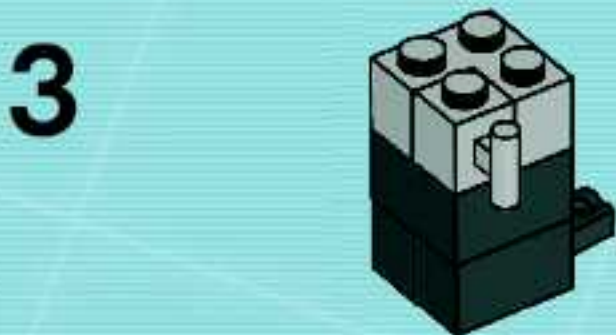
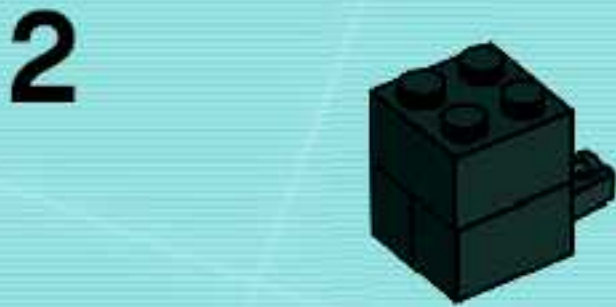
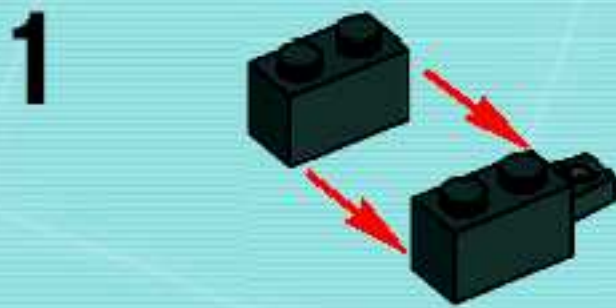

4



5

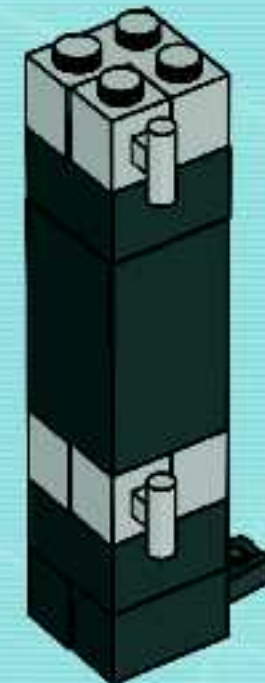

6



7

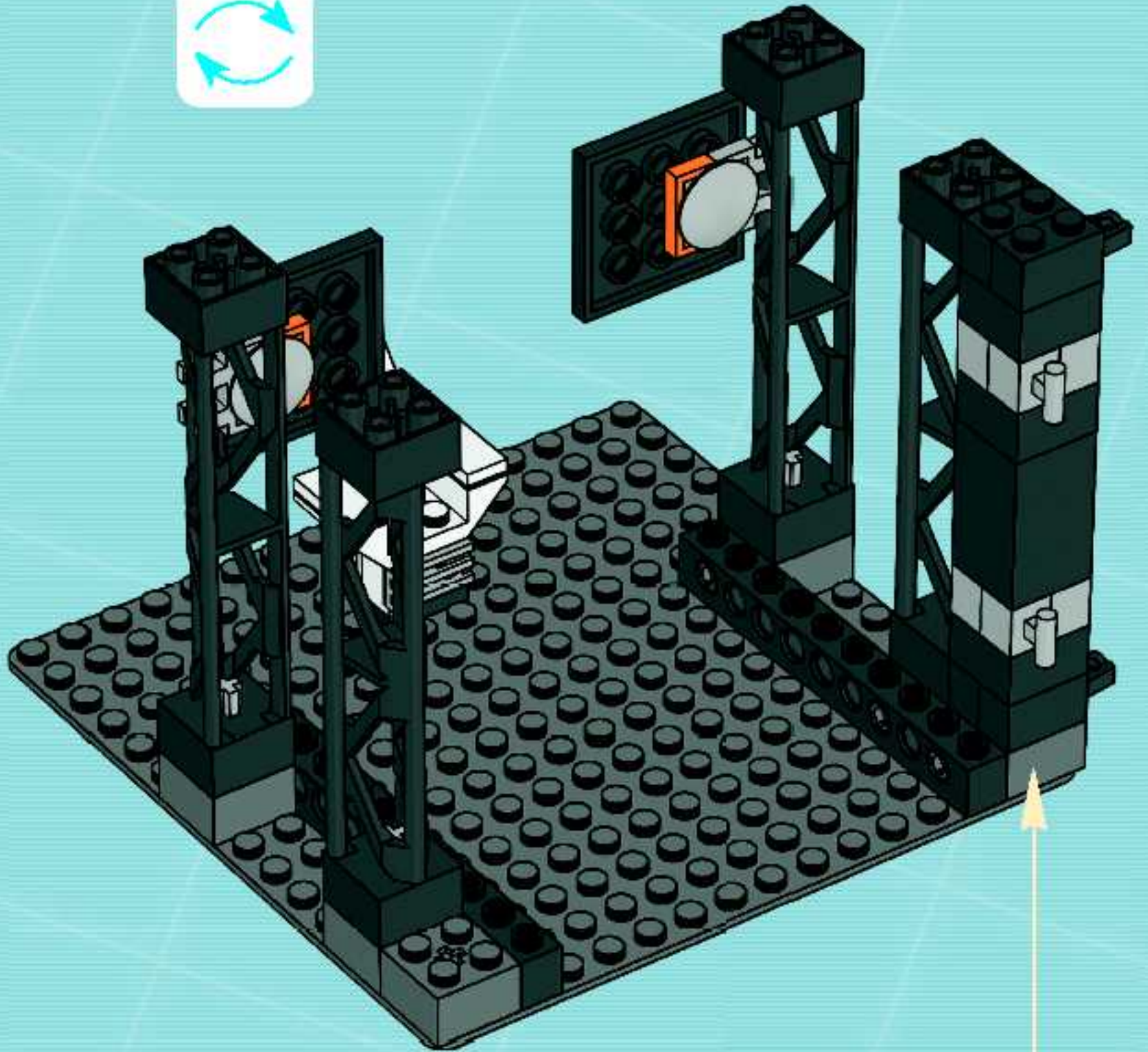
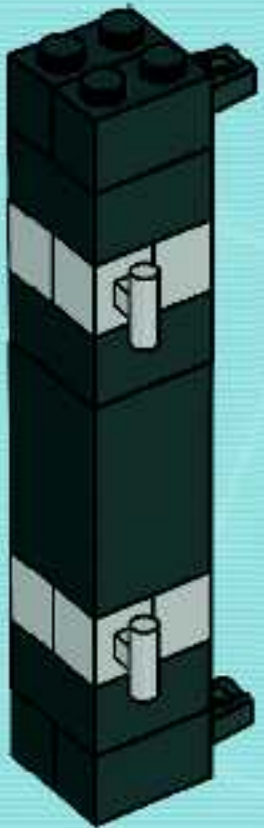

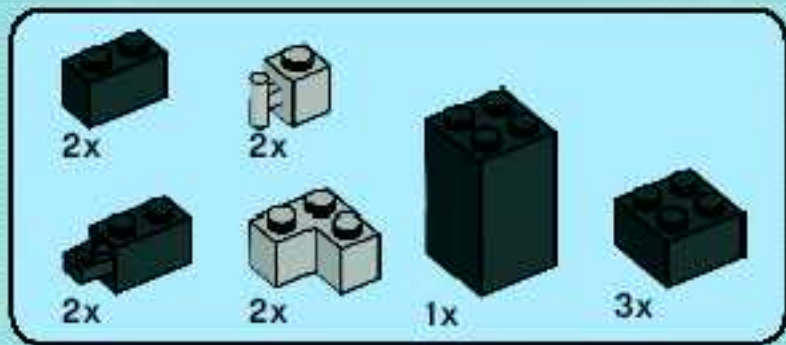

8

1

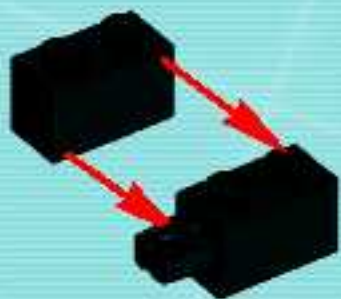

2



3



4



5



6



7

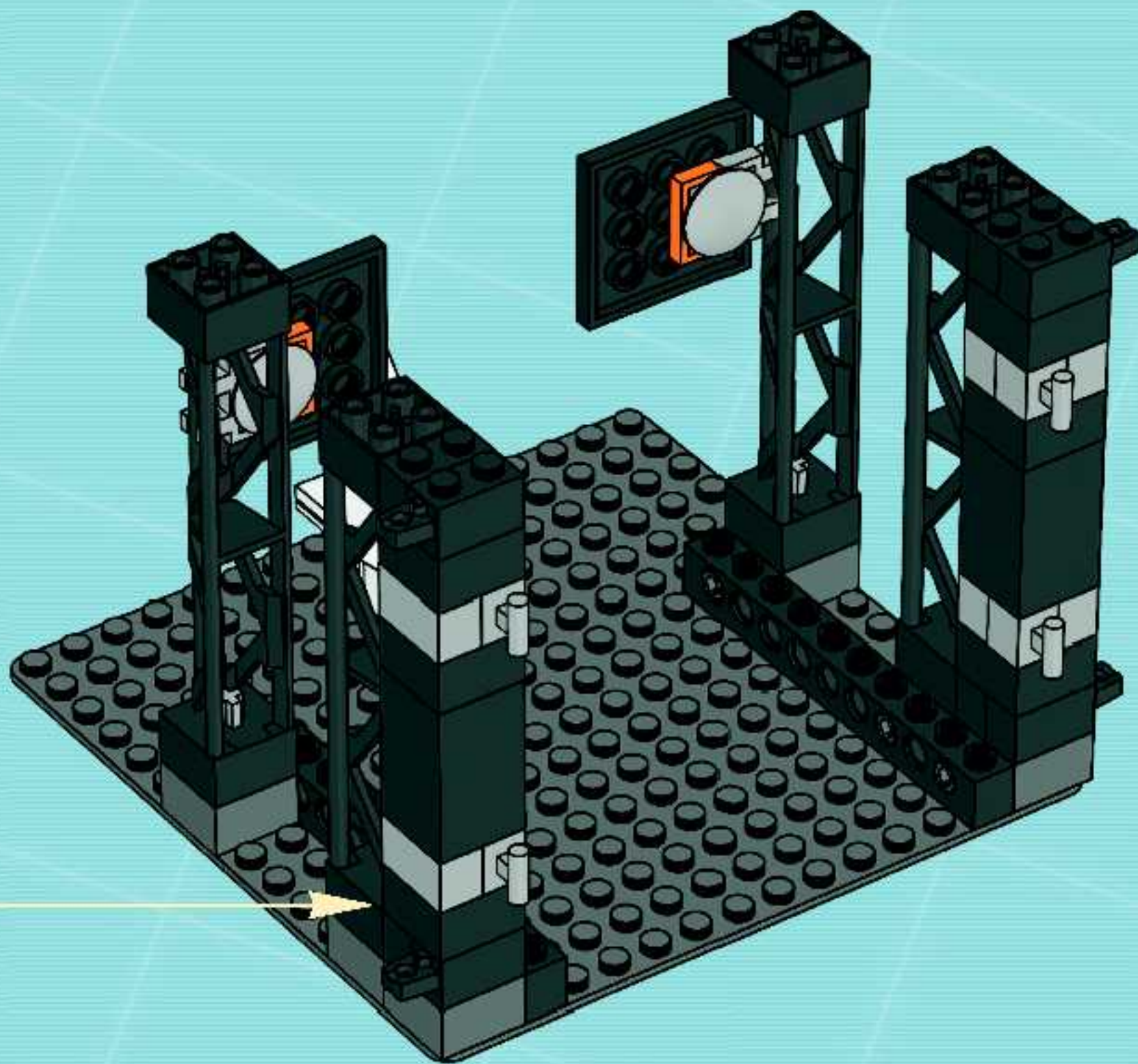



9

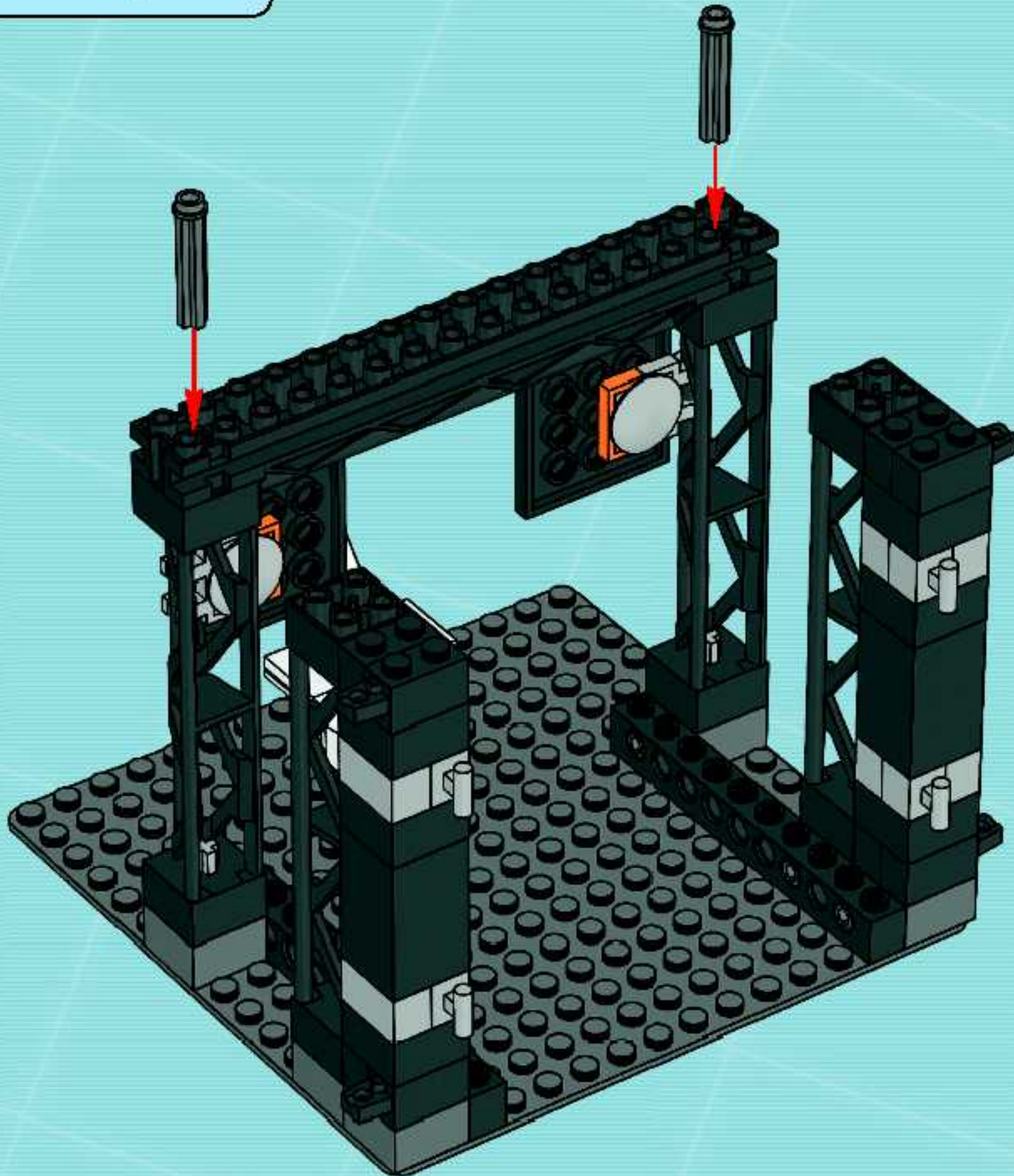



2x

10

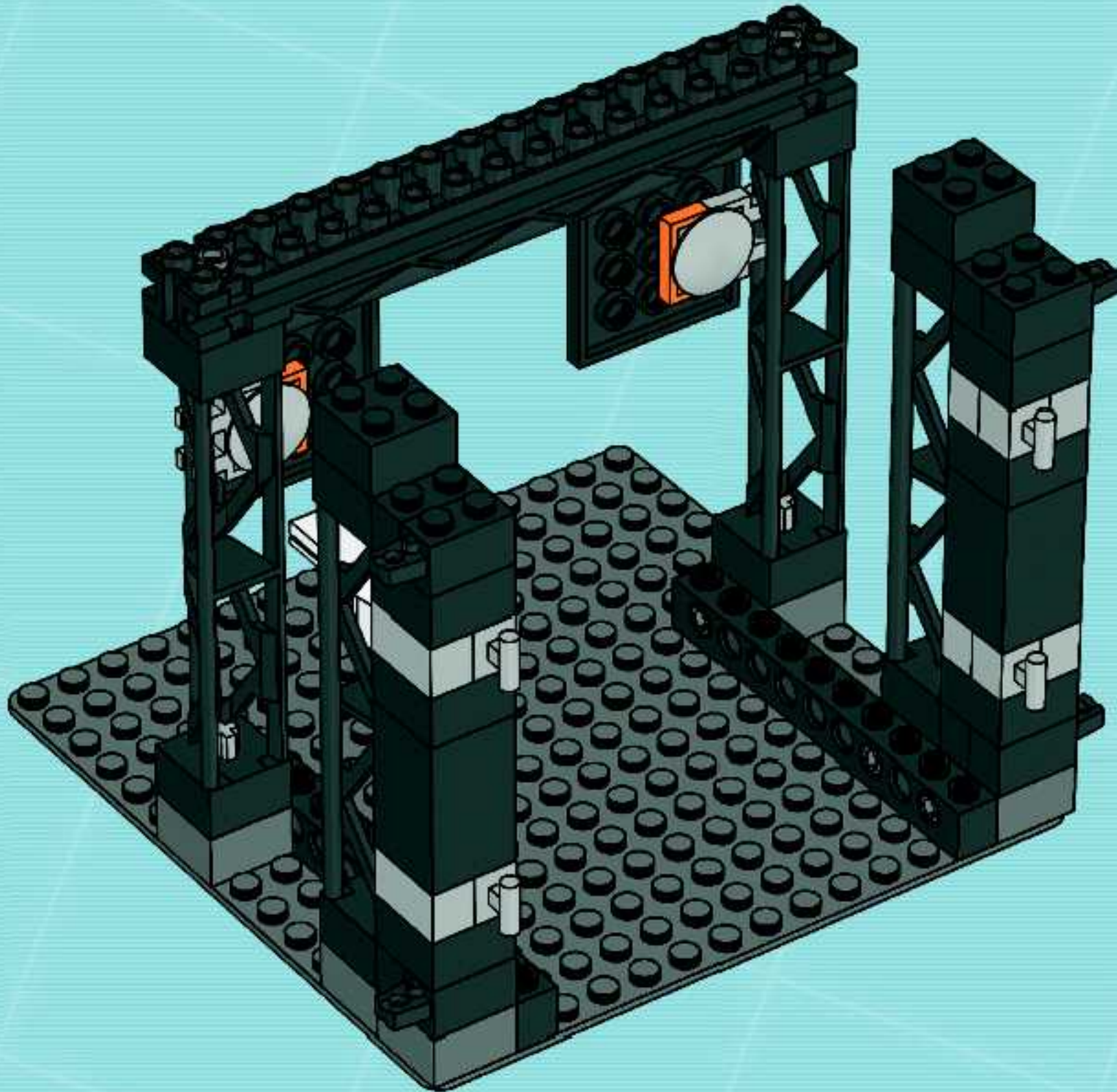

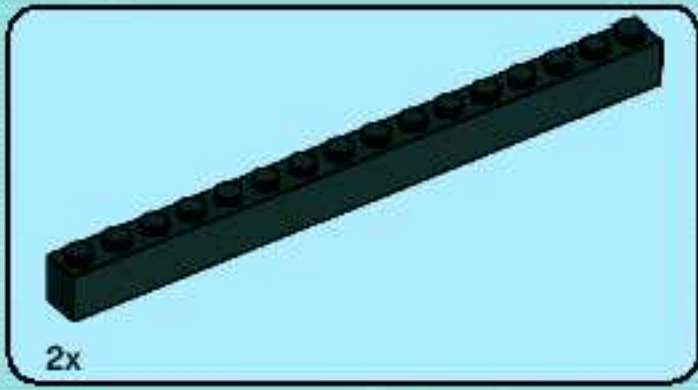

11

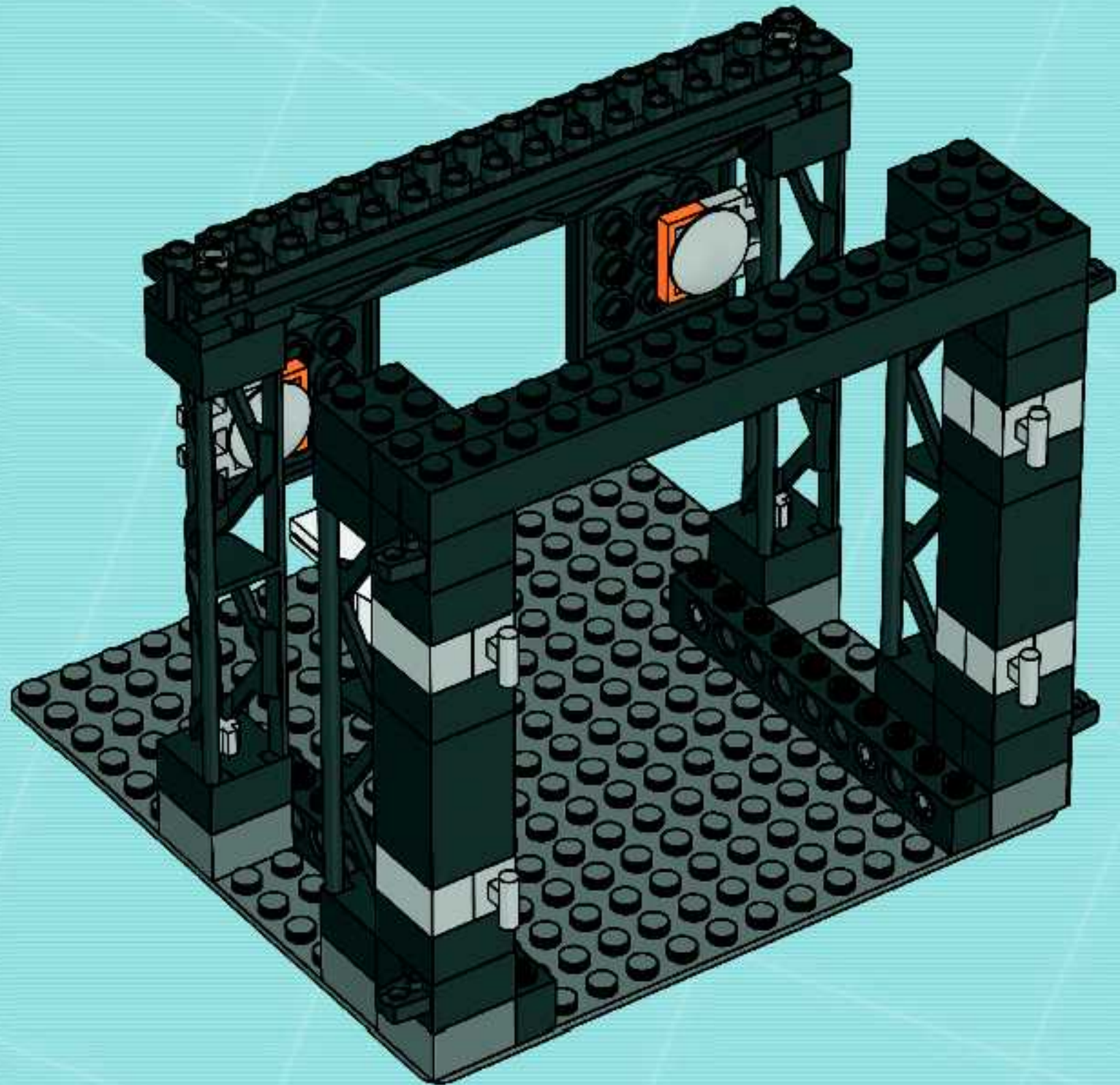

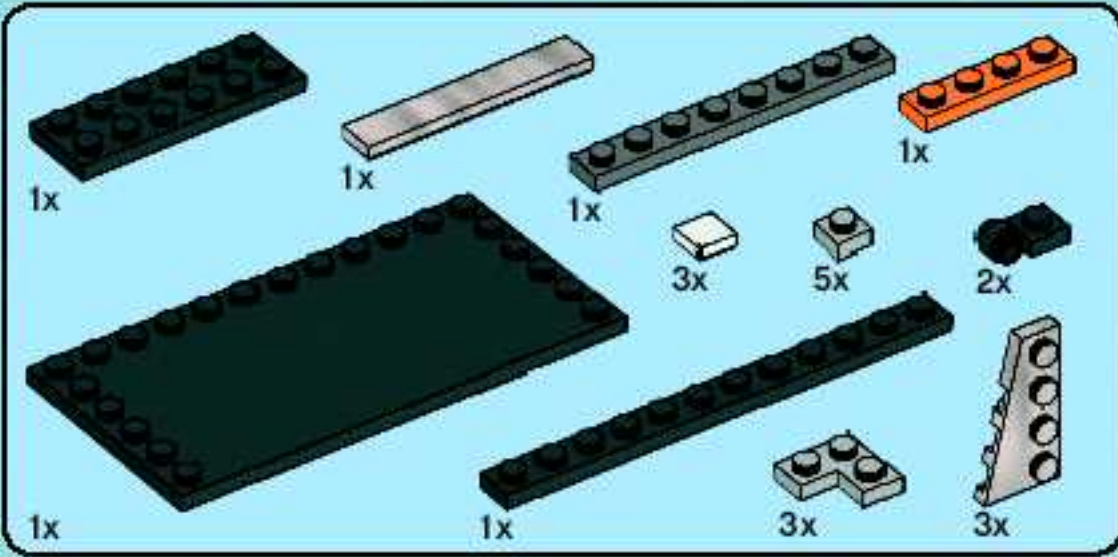
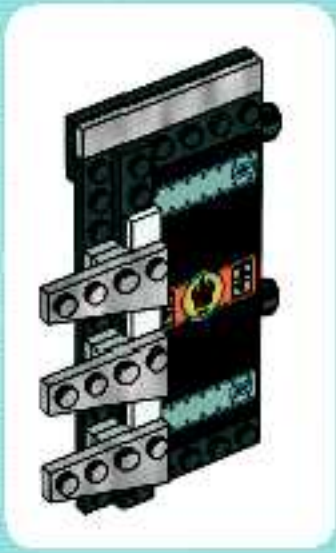

12

1



2

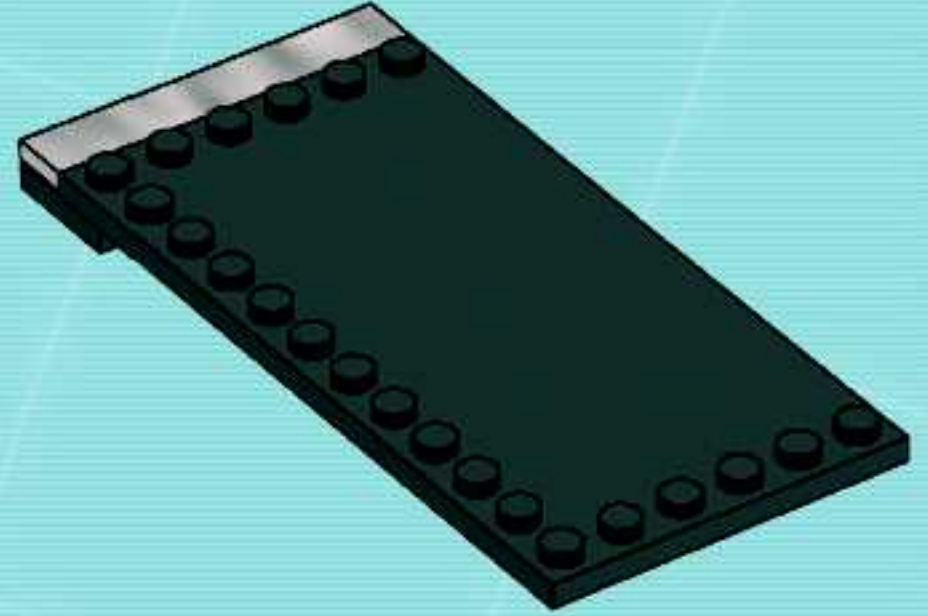

3





4

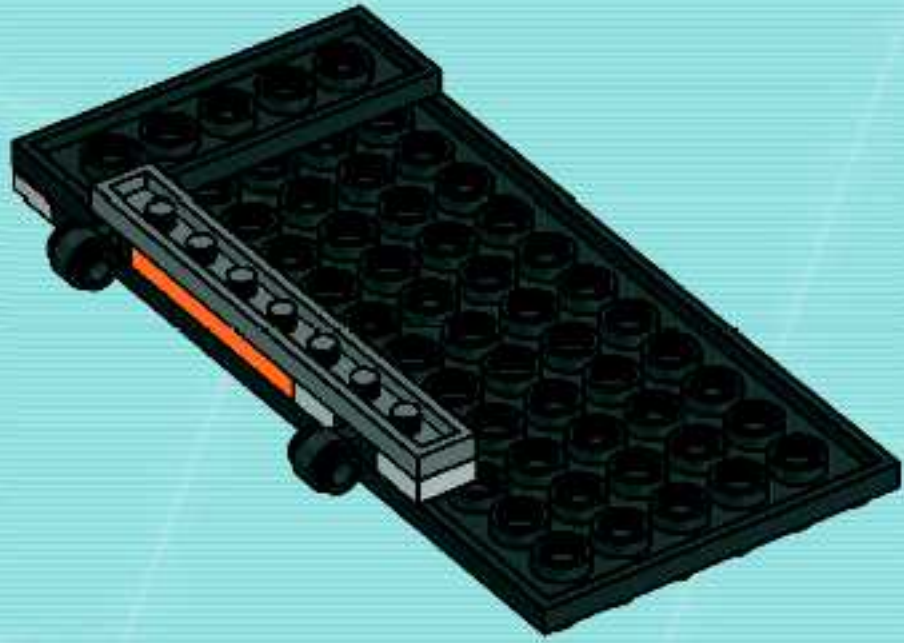

6

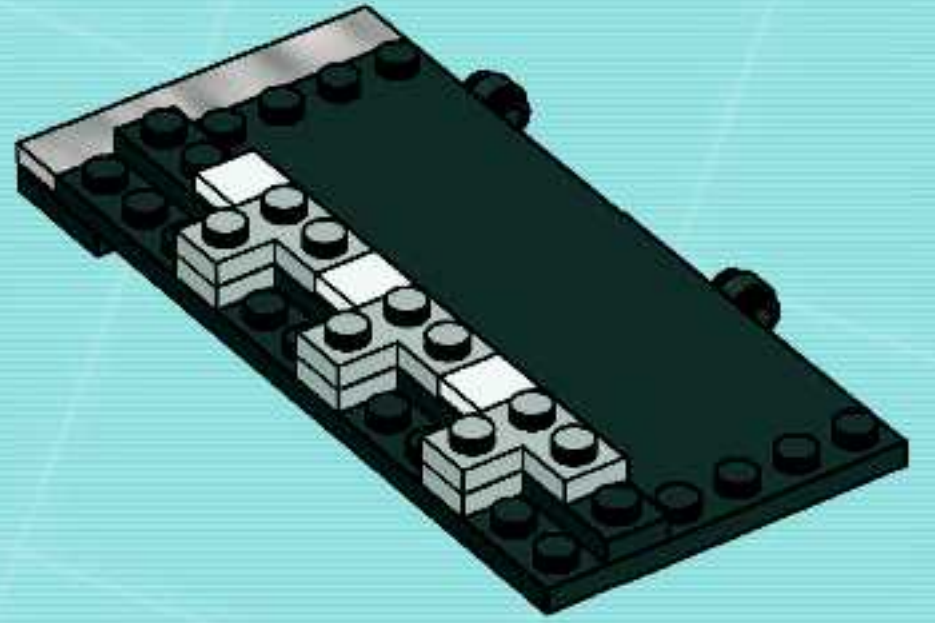

5

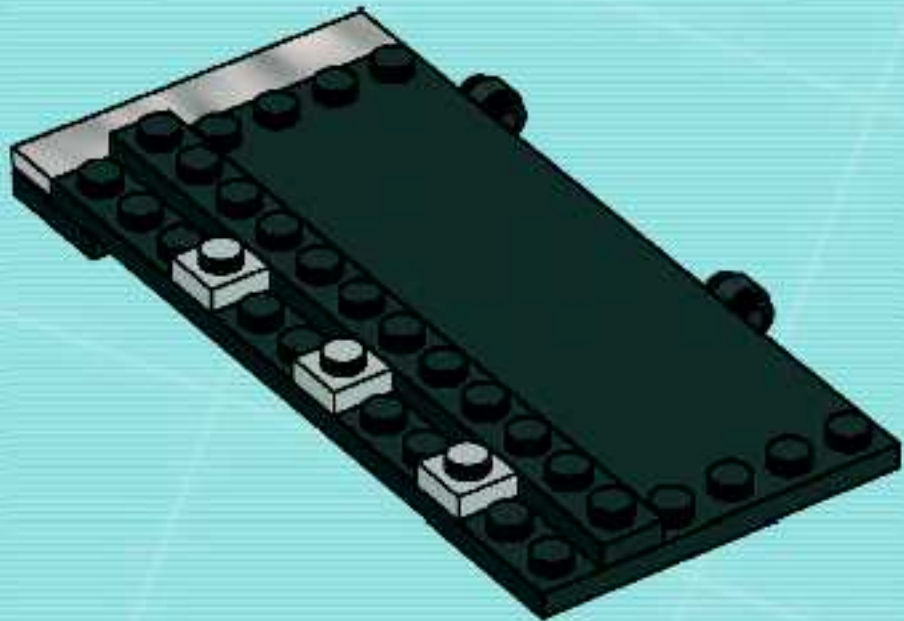

7

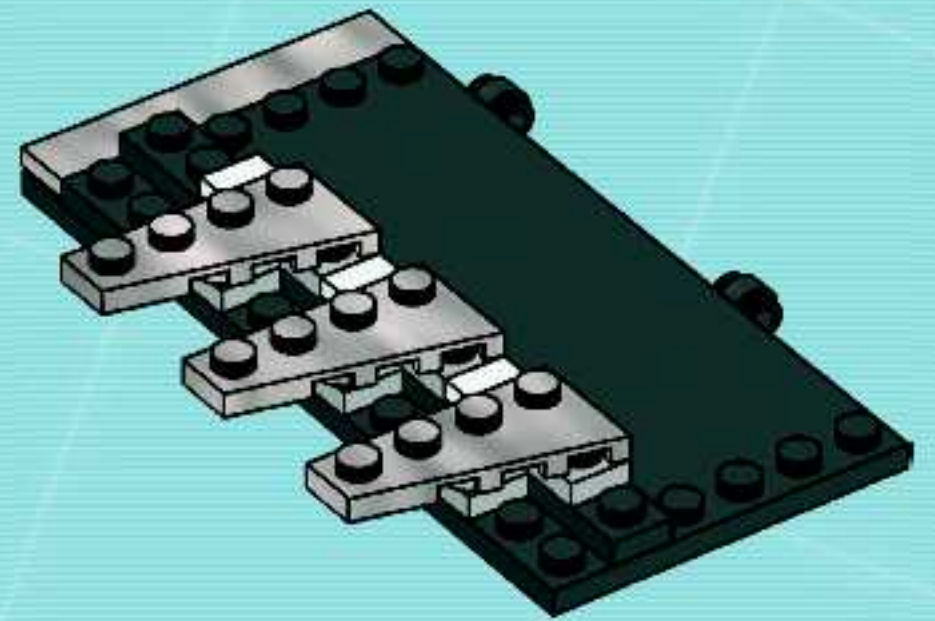

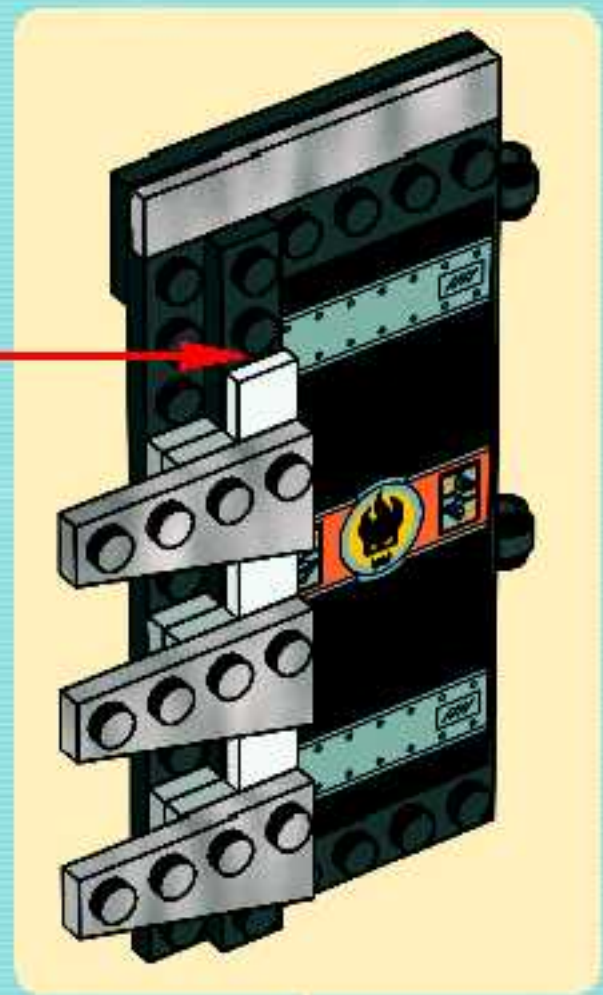
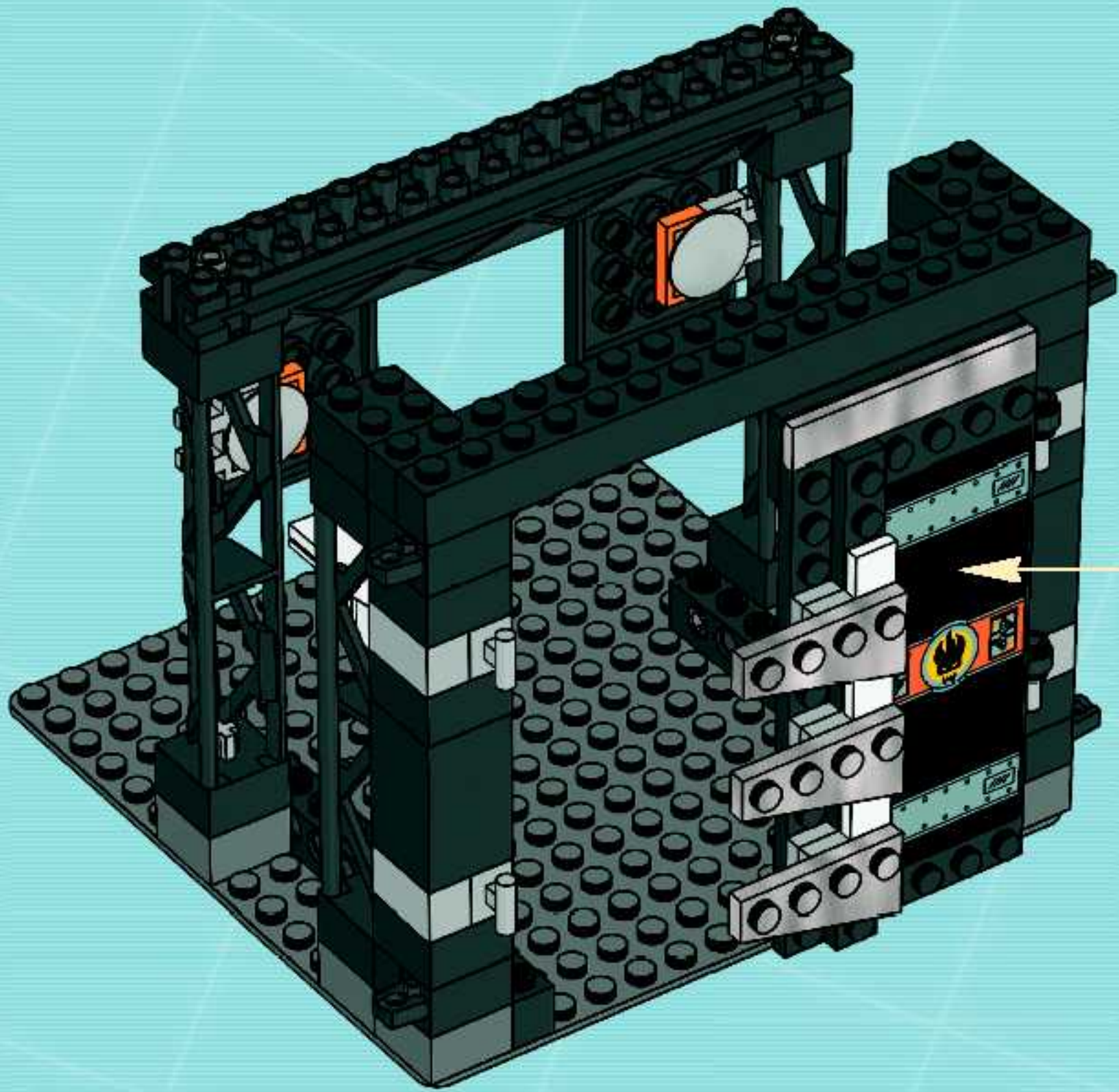

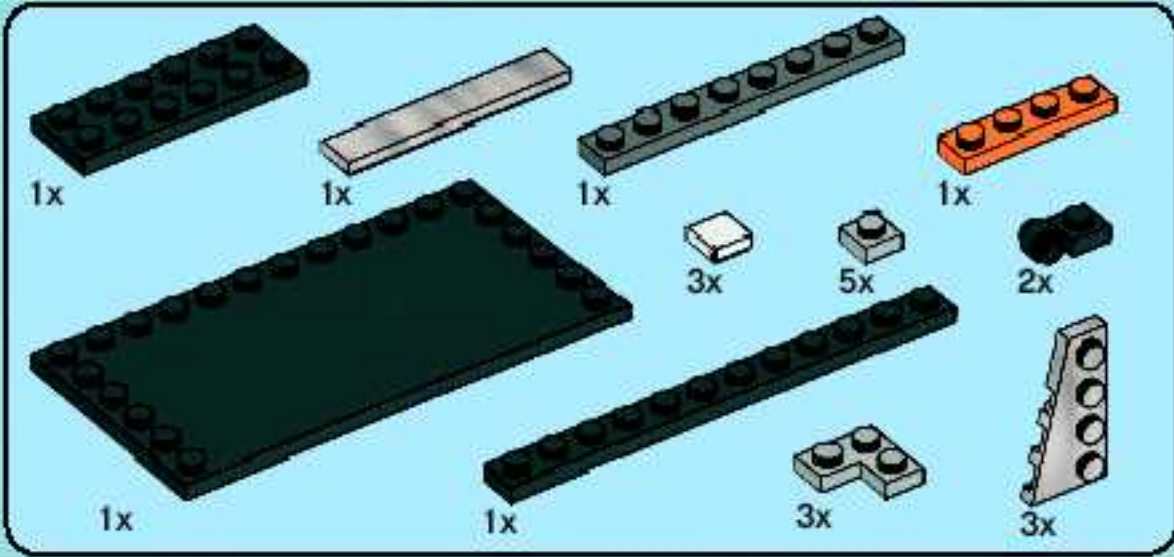
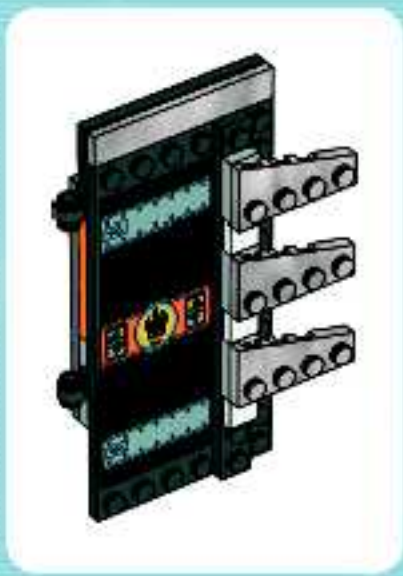

13

1



2

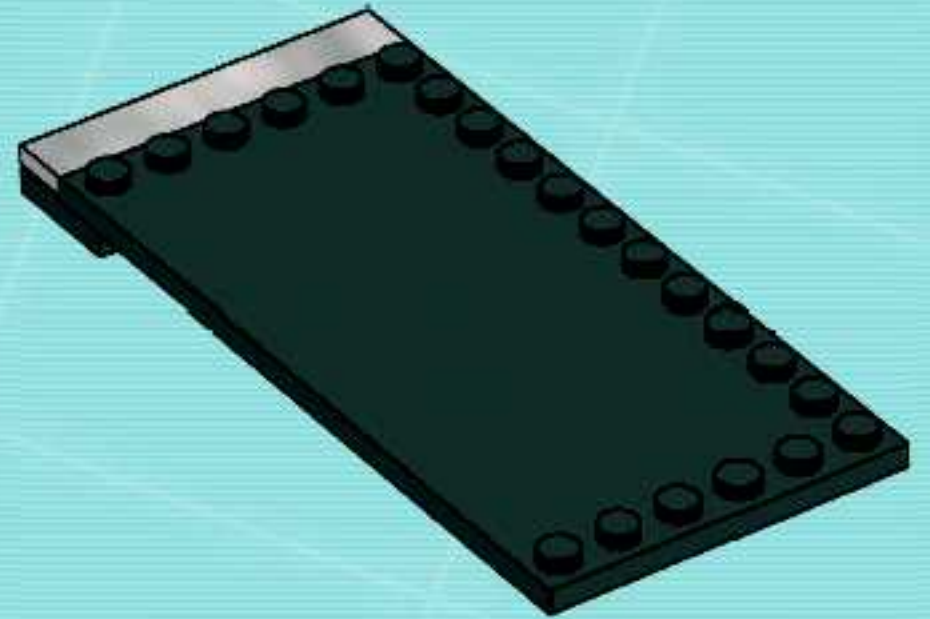

3

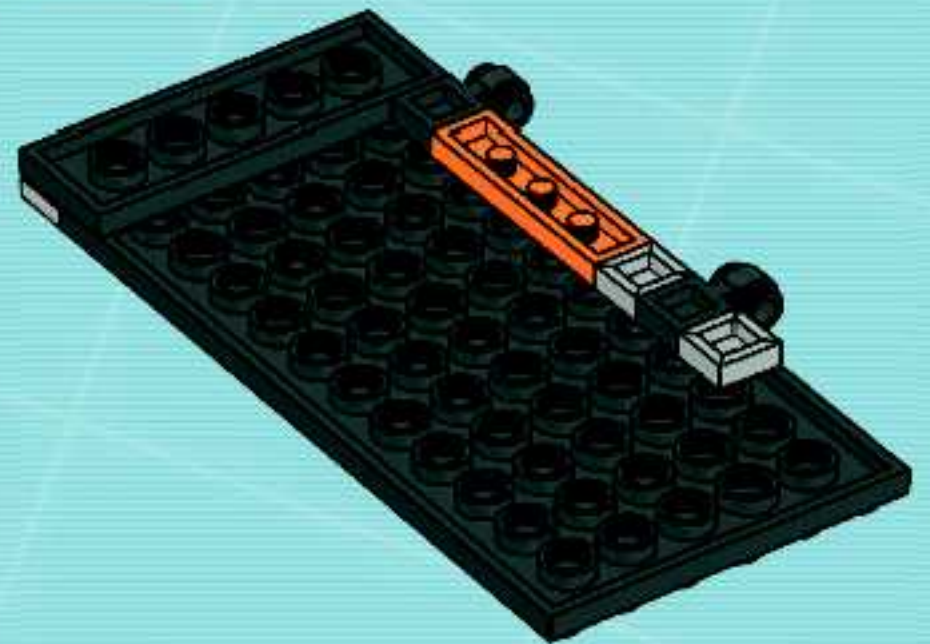

4

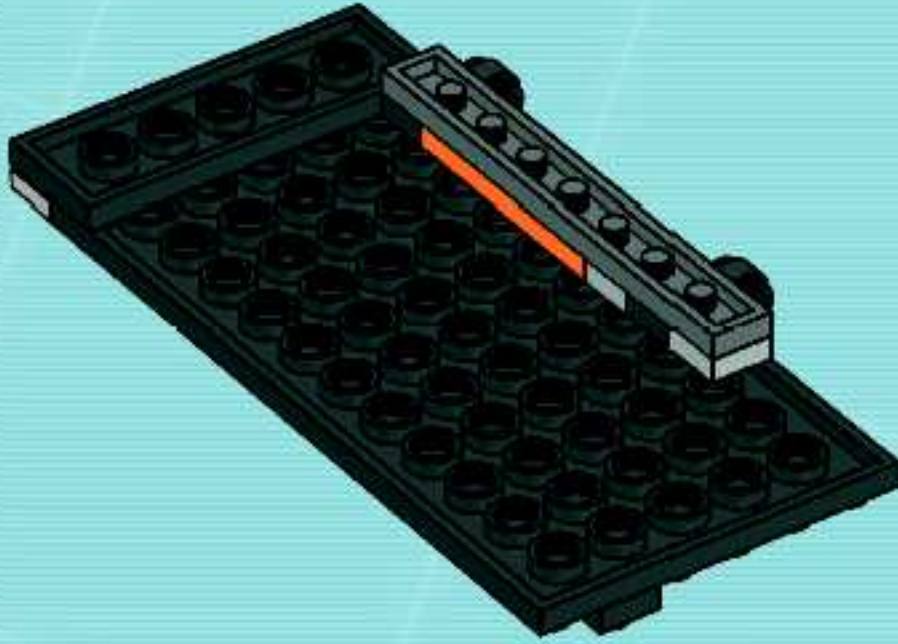

6

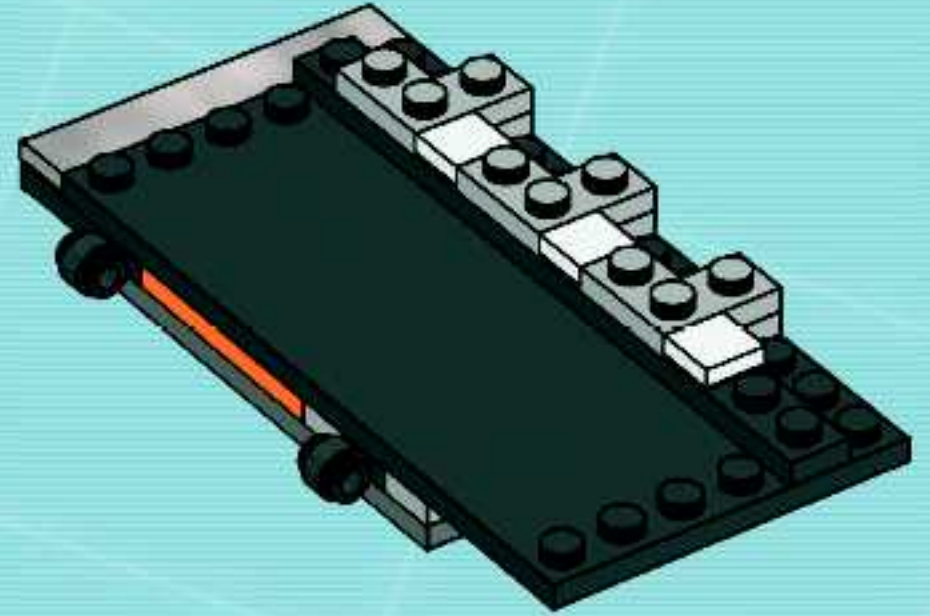

5

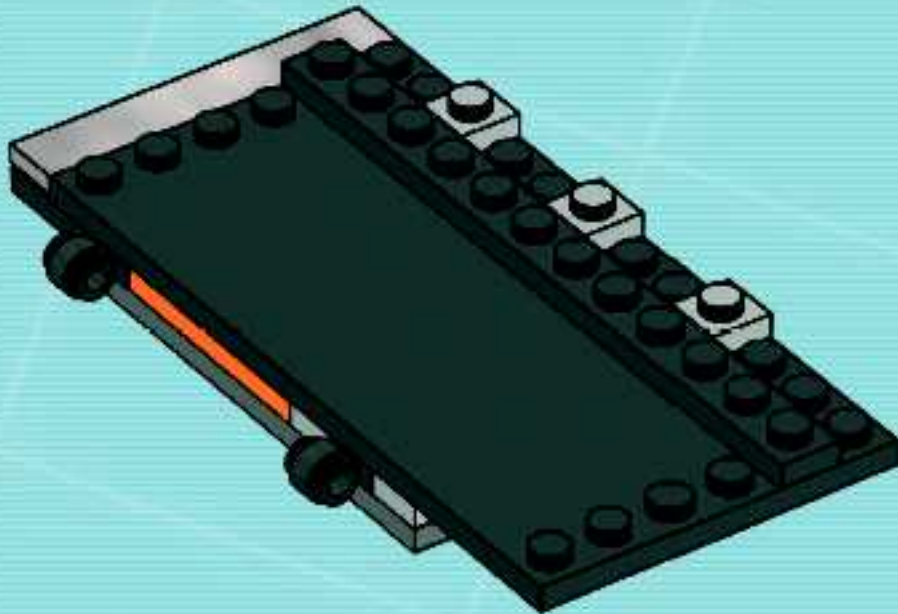

7

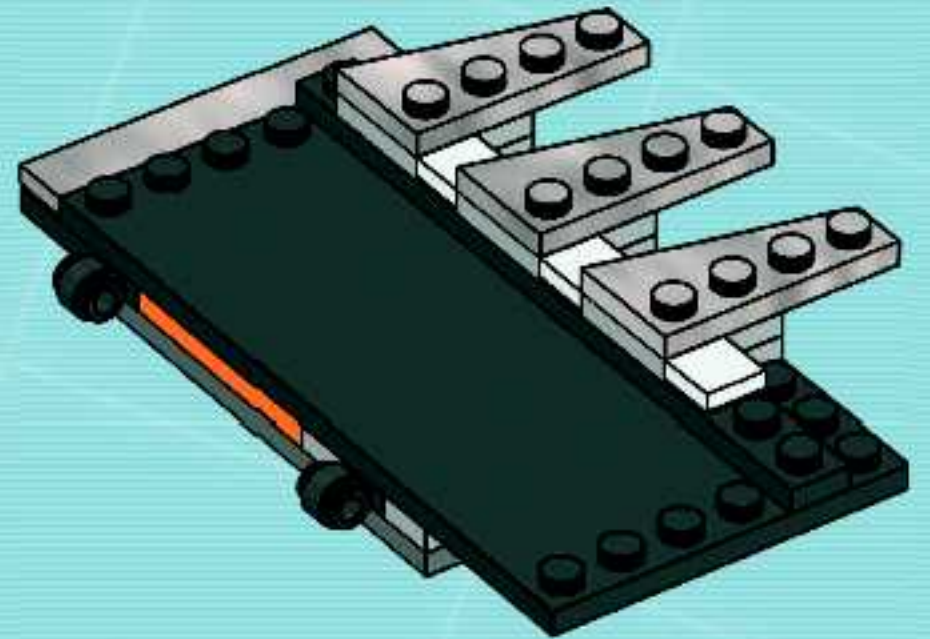

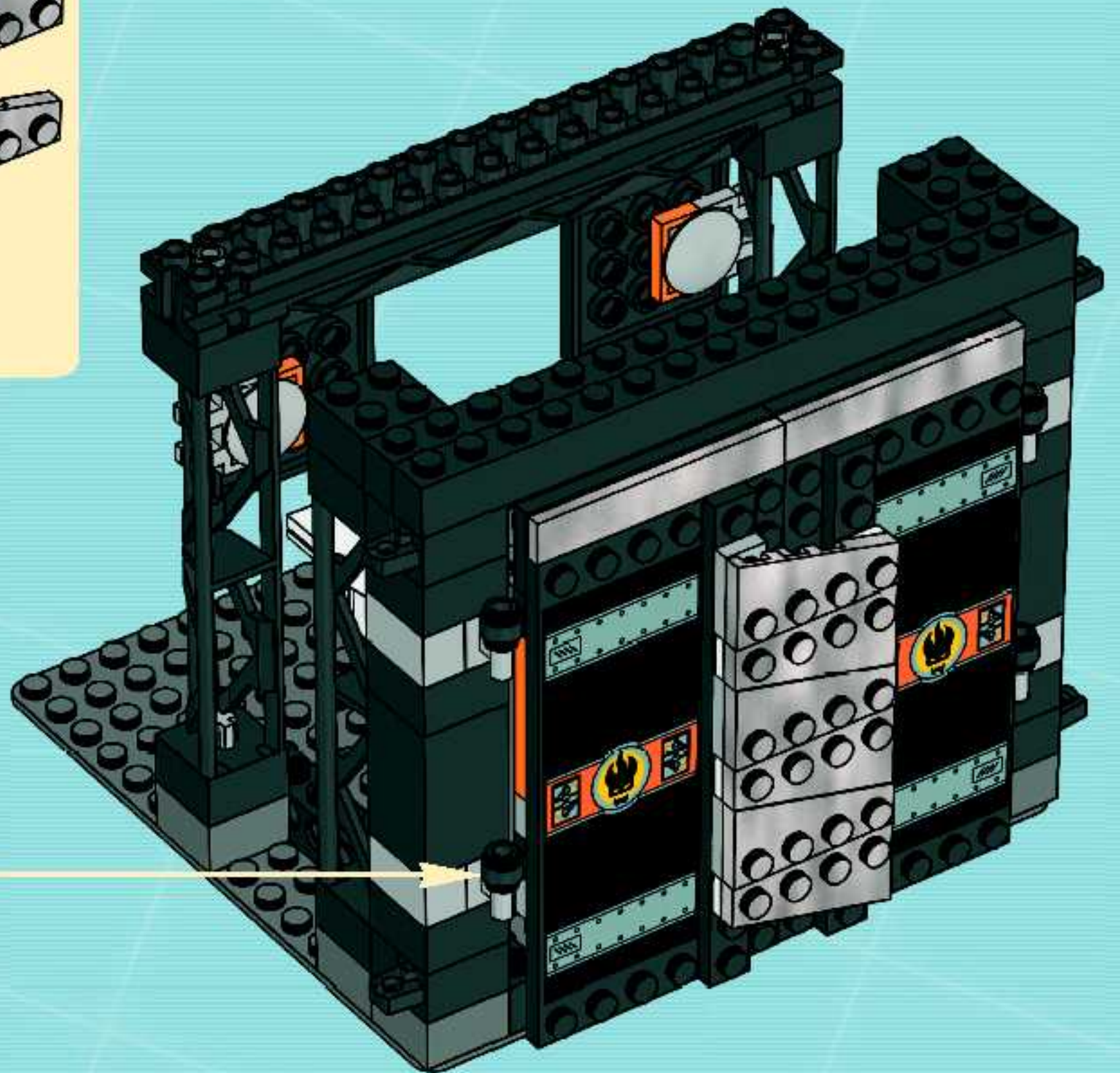
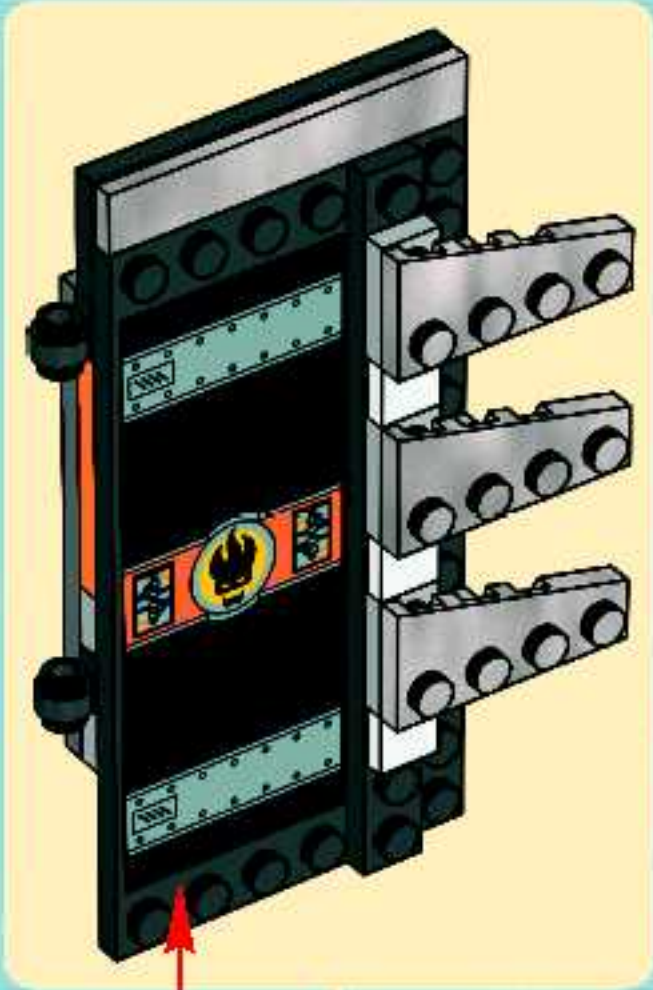

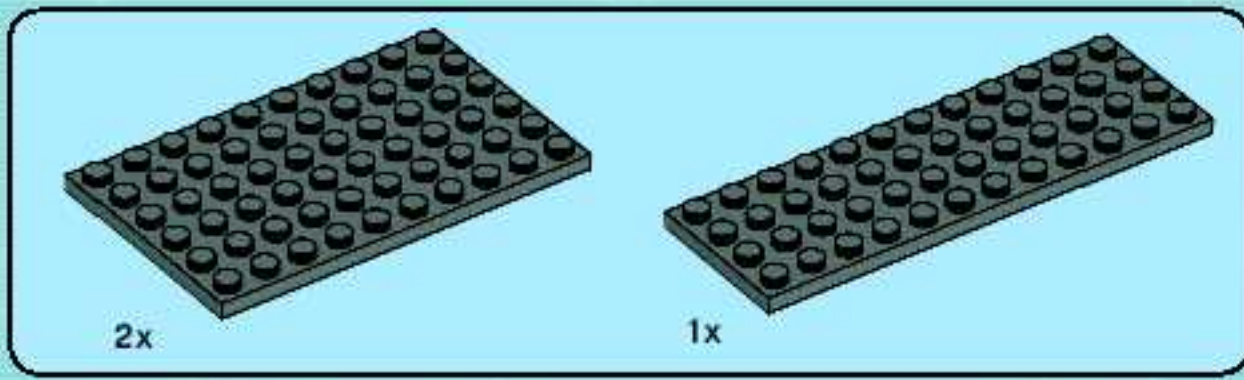

14

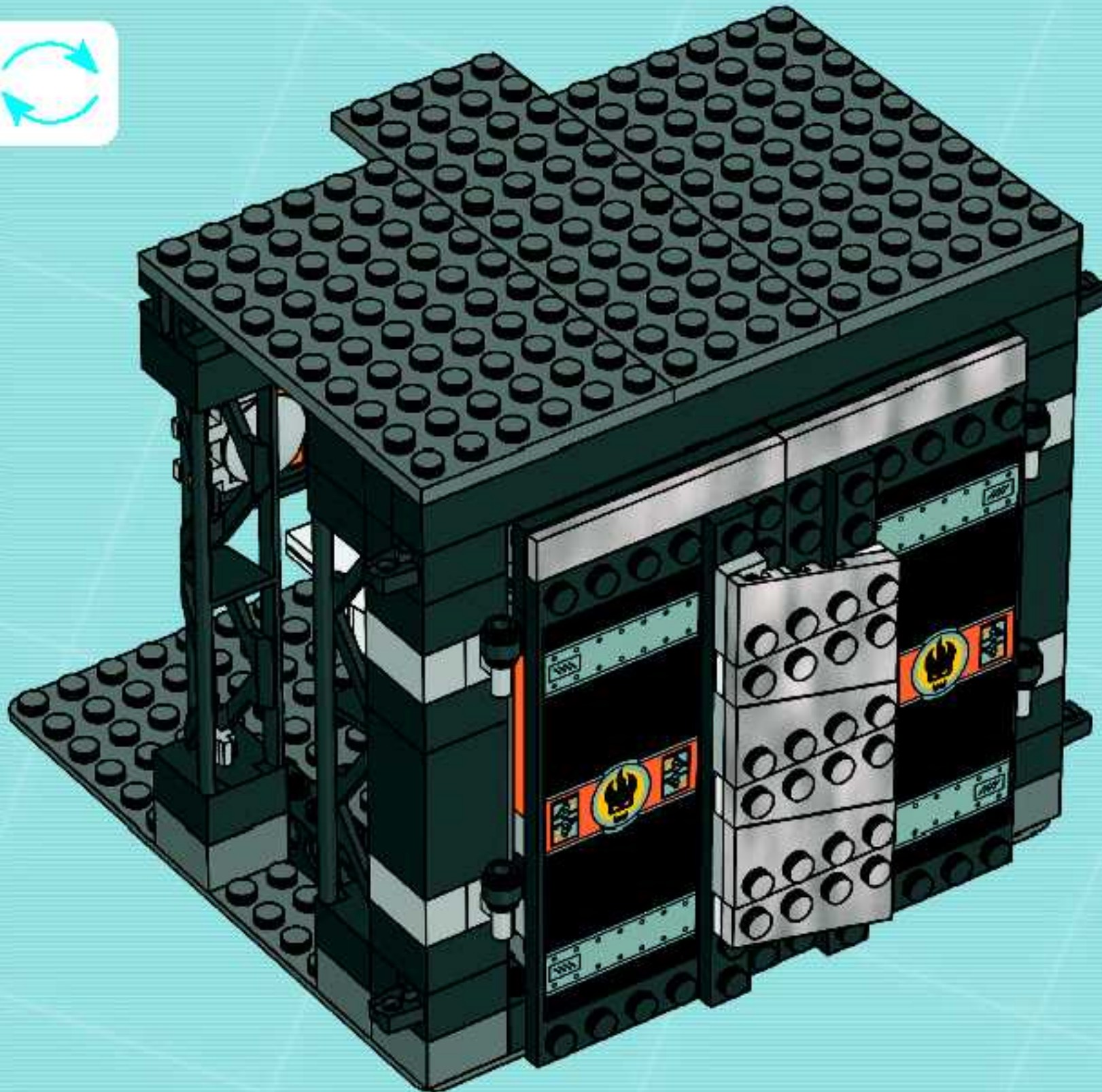

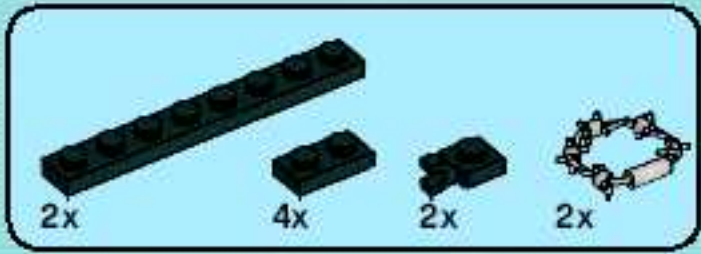
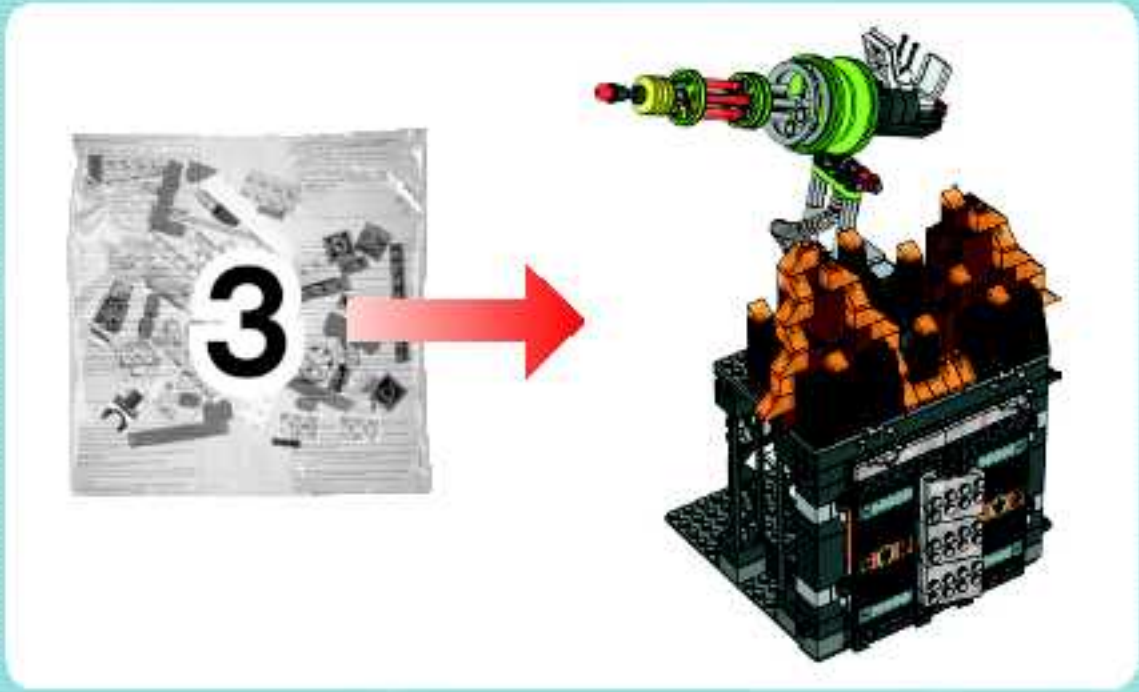

15

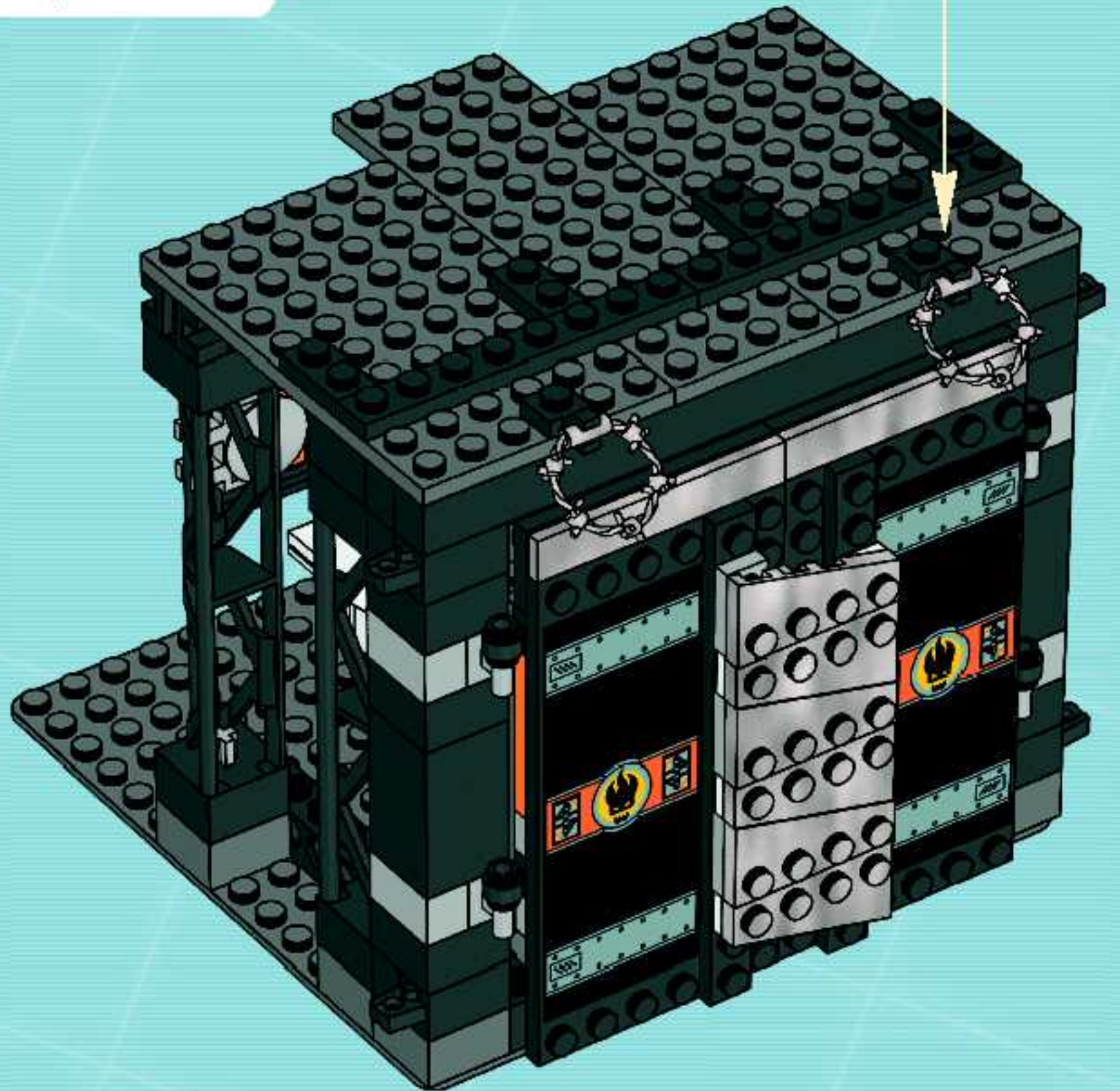

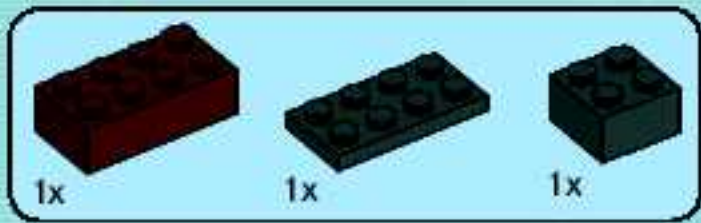

16

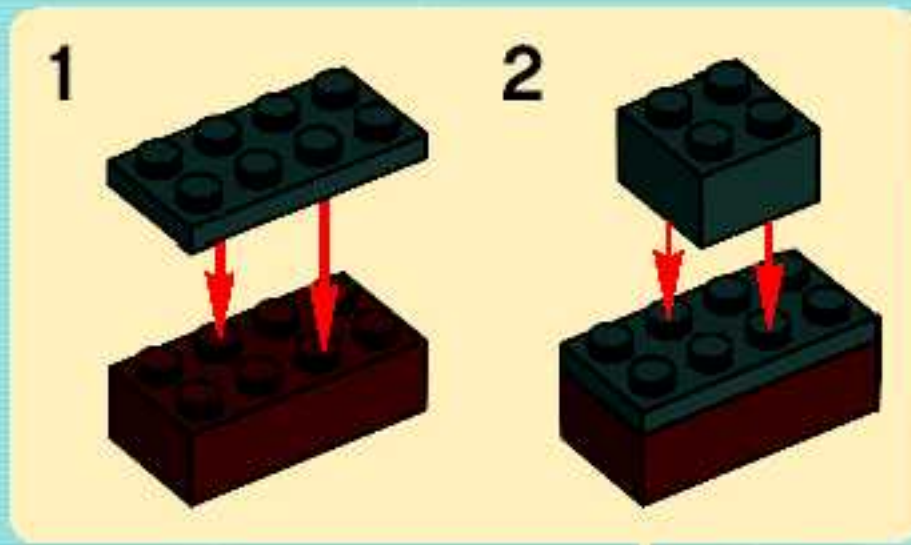



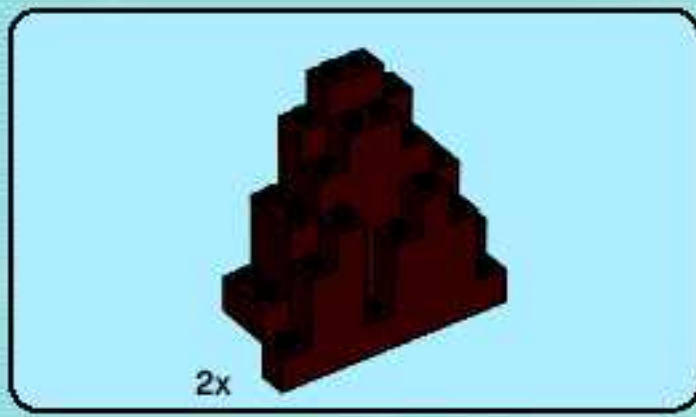

17

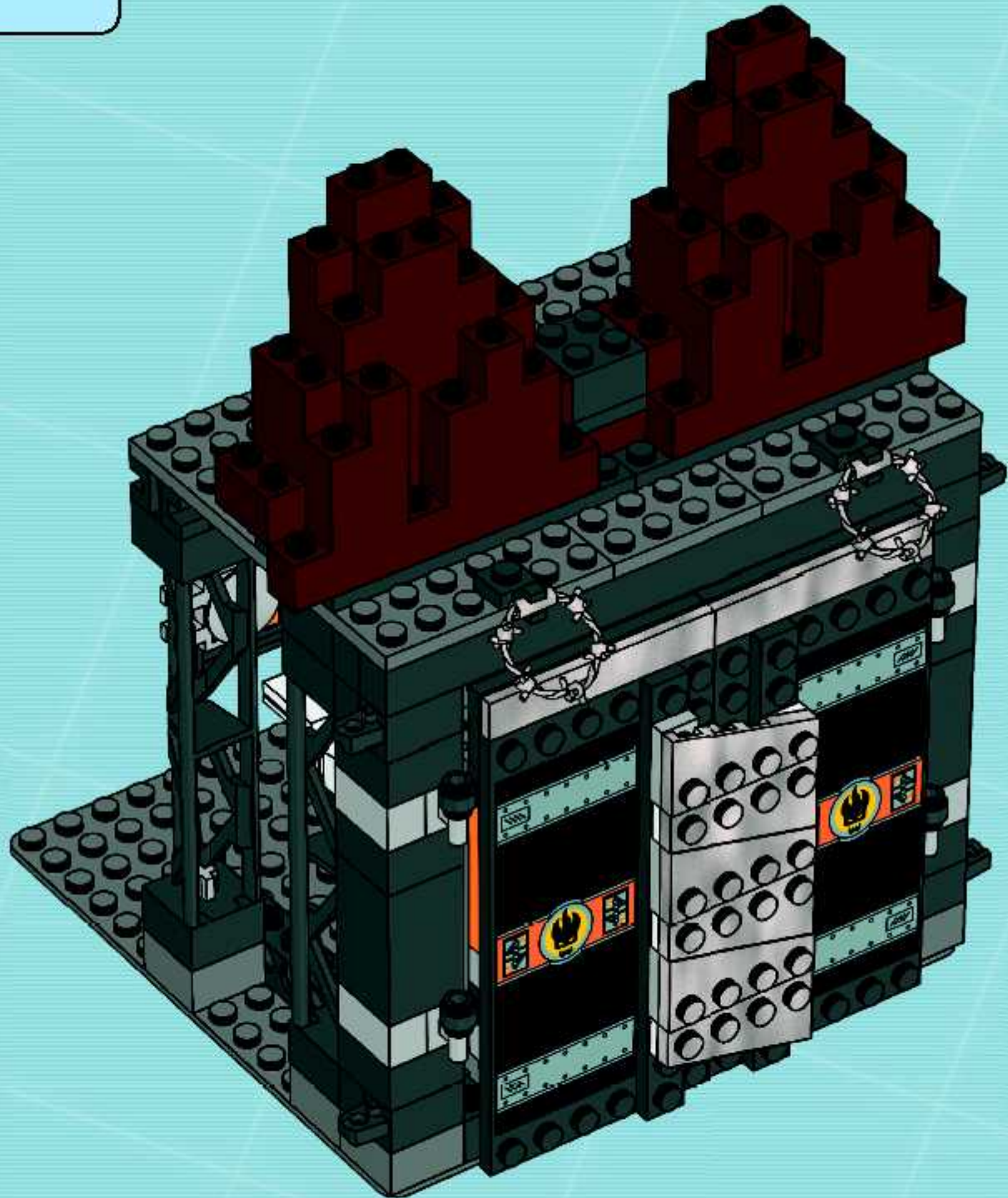



10x

18

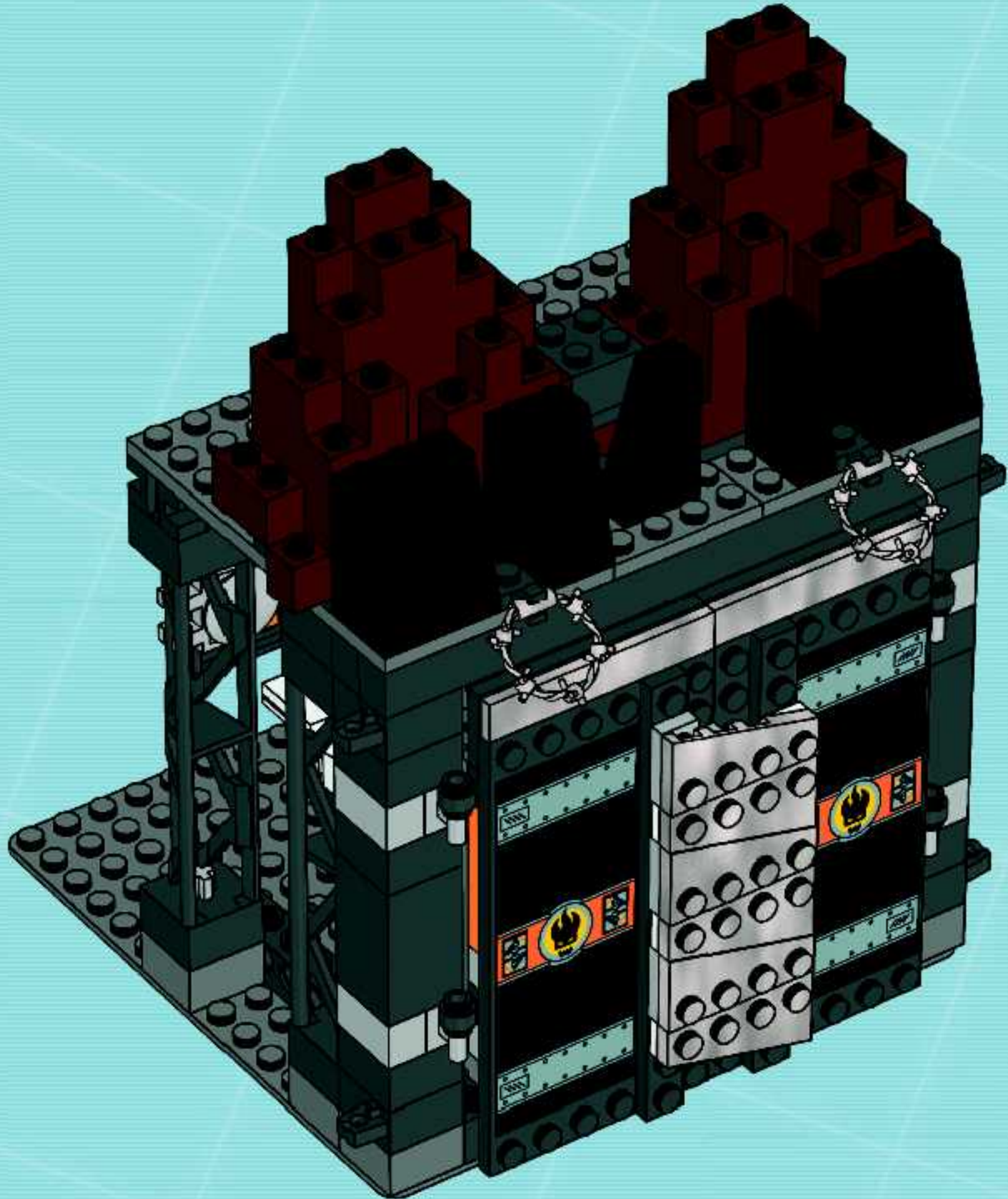

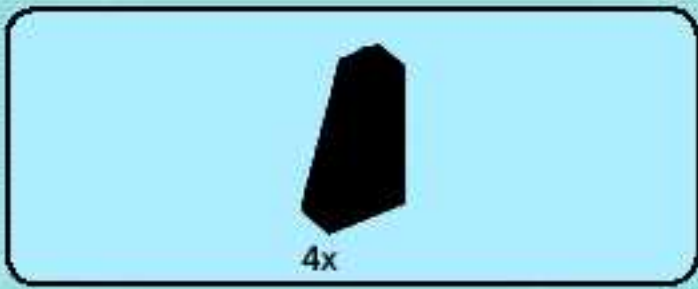

19

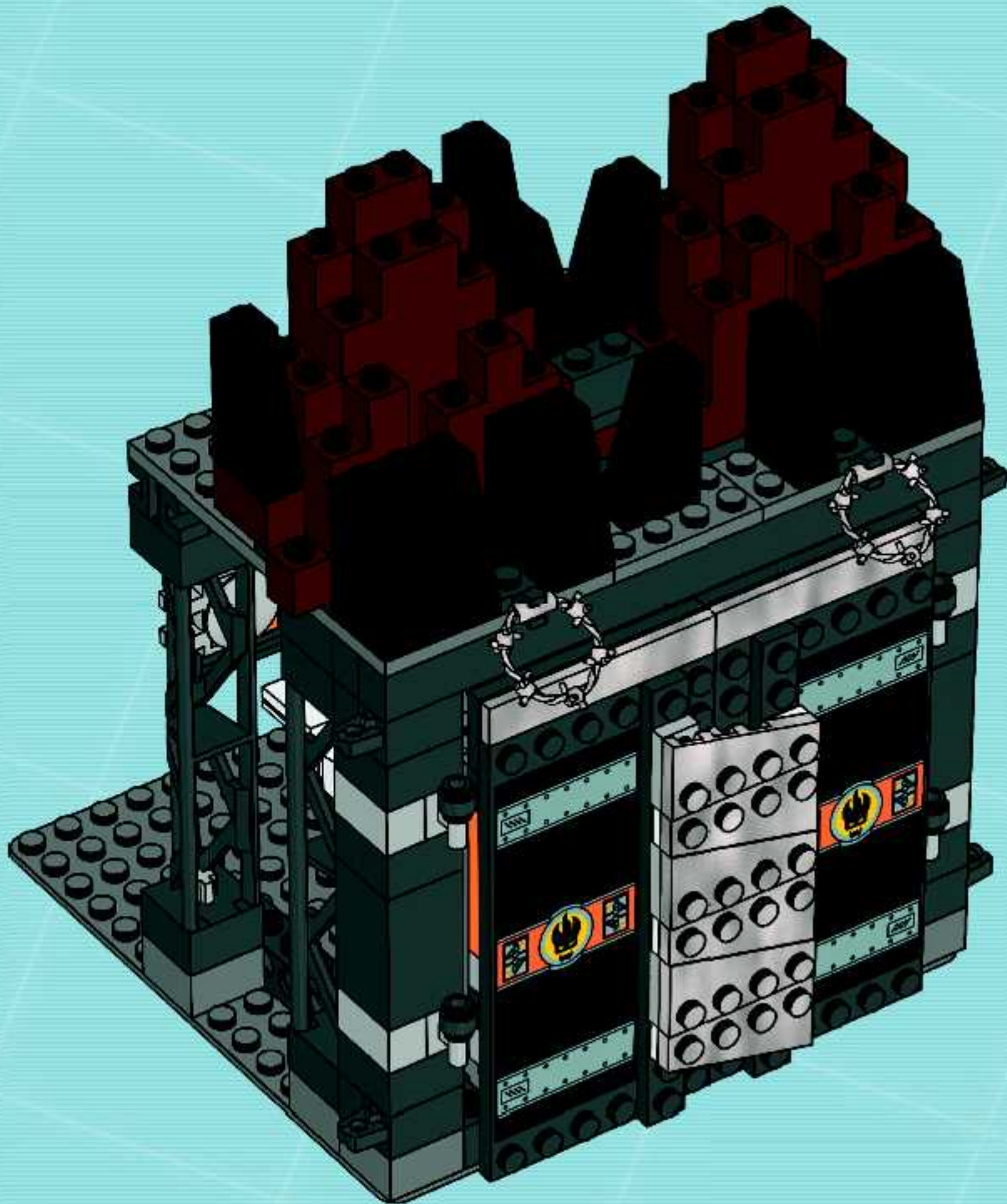



3x



2x

# 20

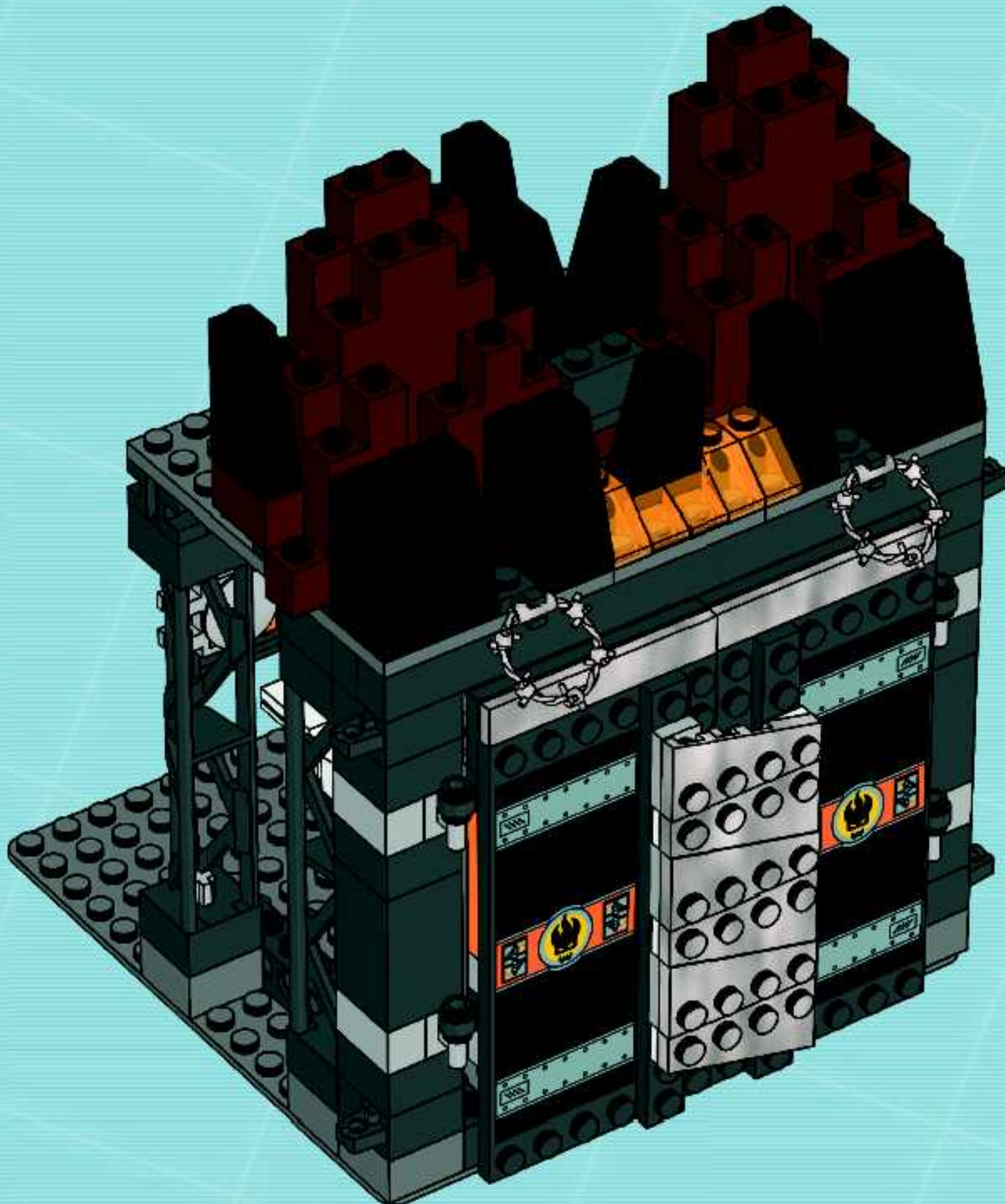



3x



1x

# 21

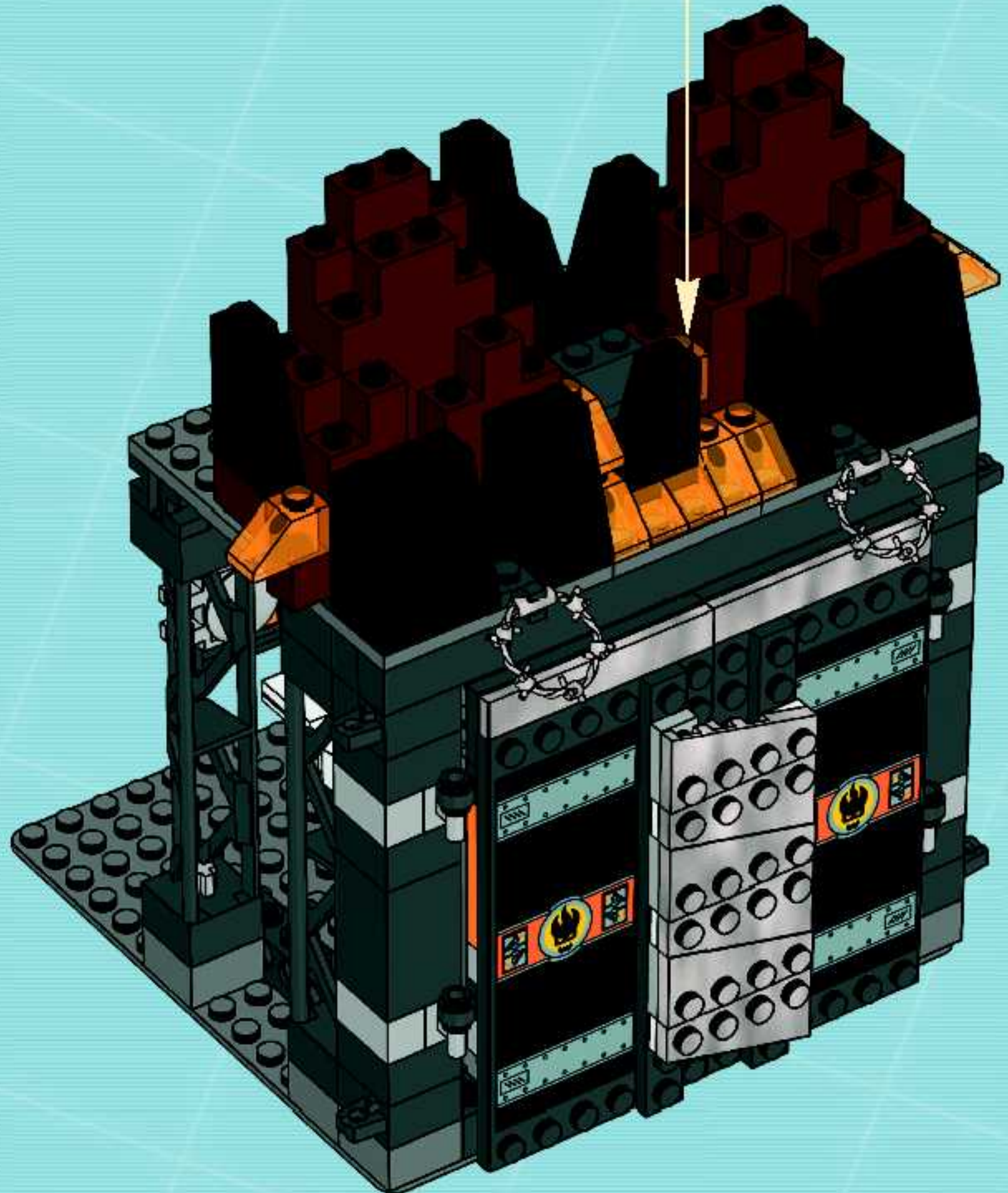



22

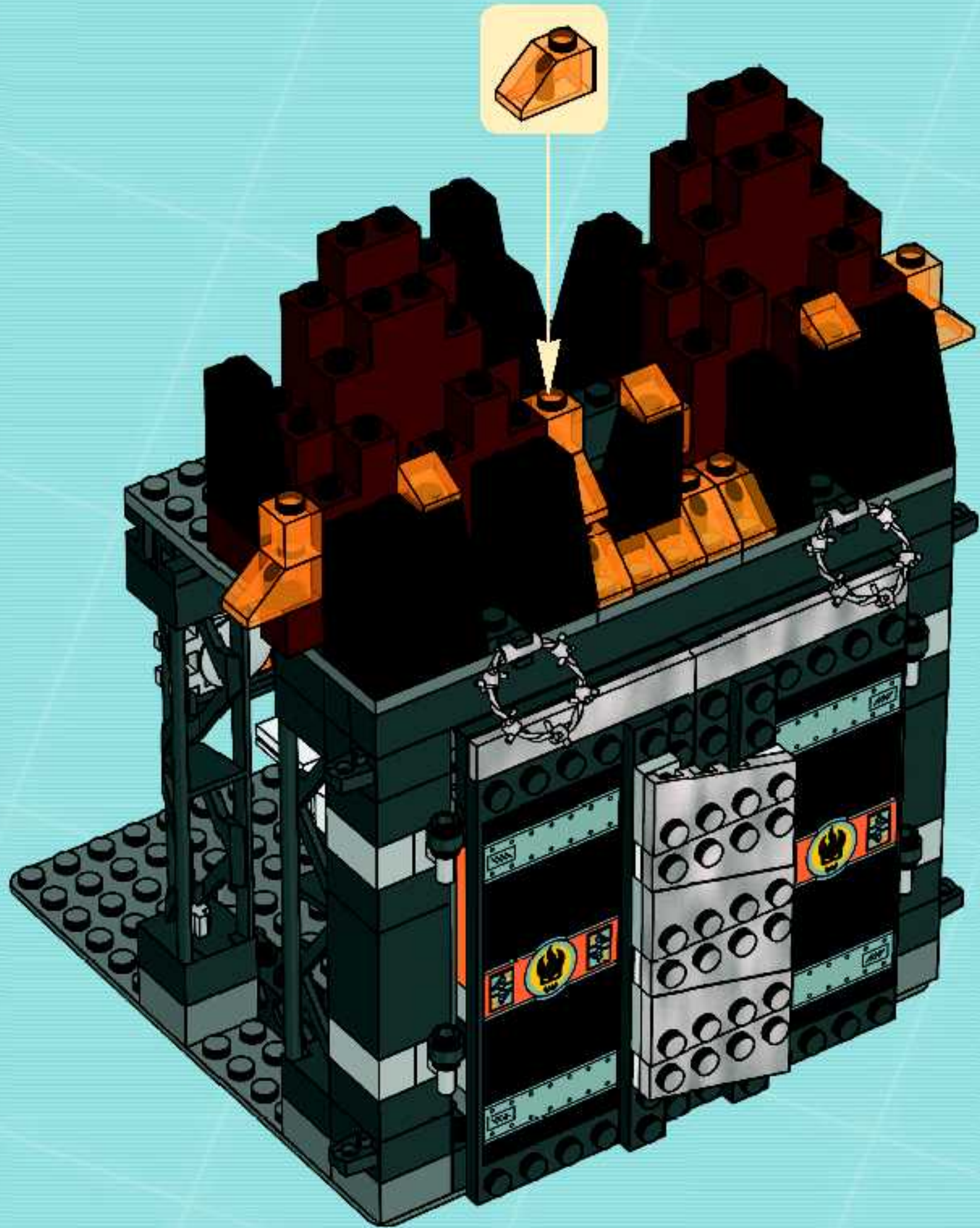



3x

23

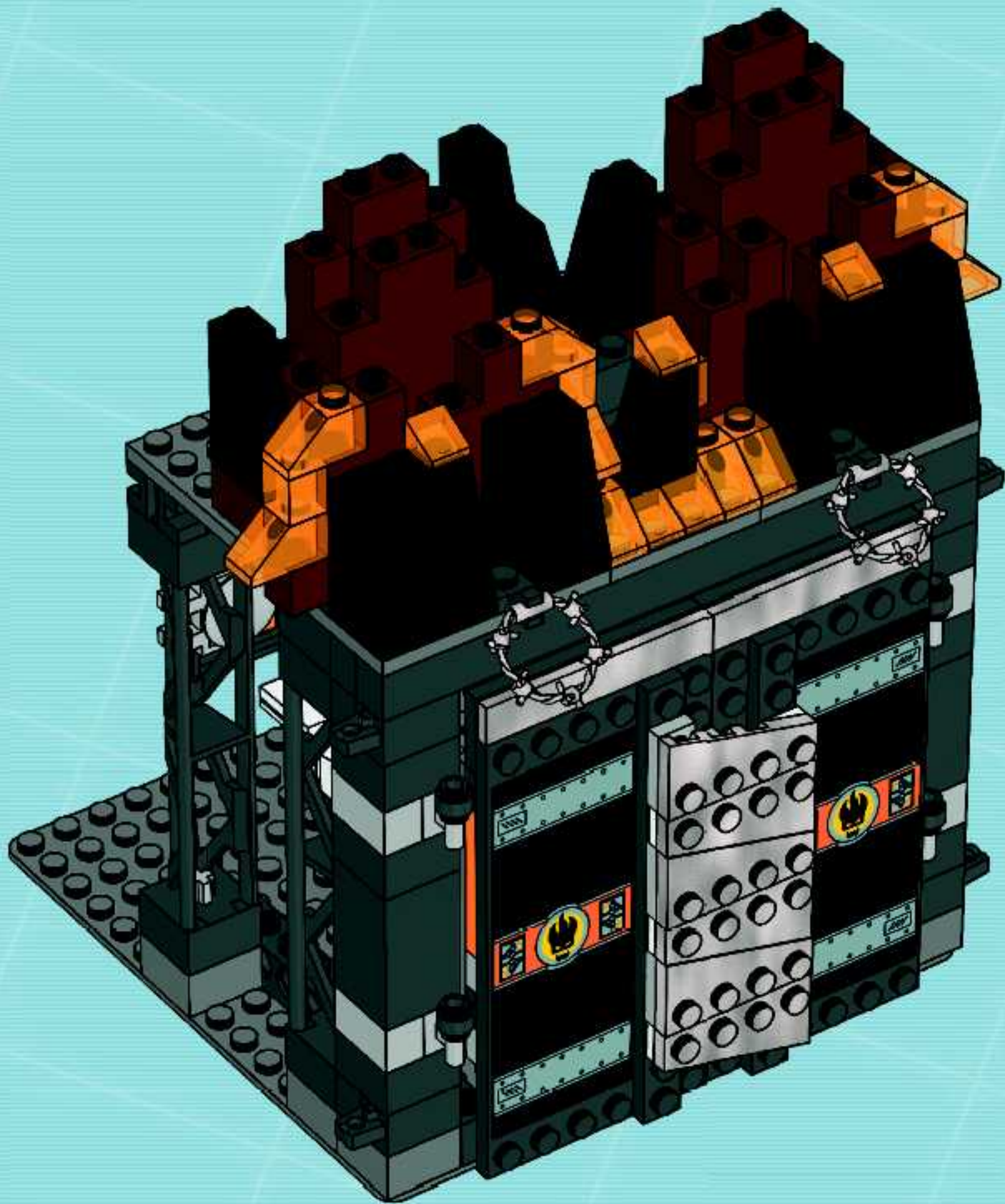

1x  3x 

24

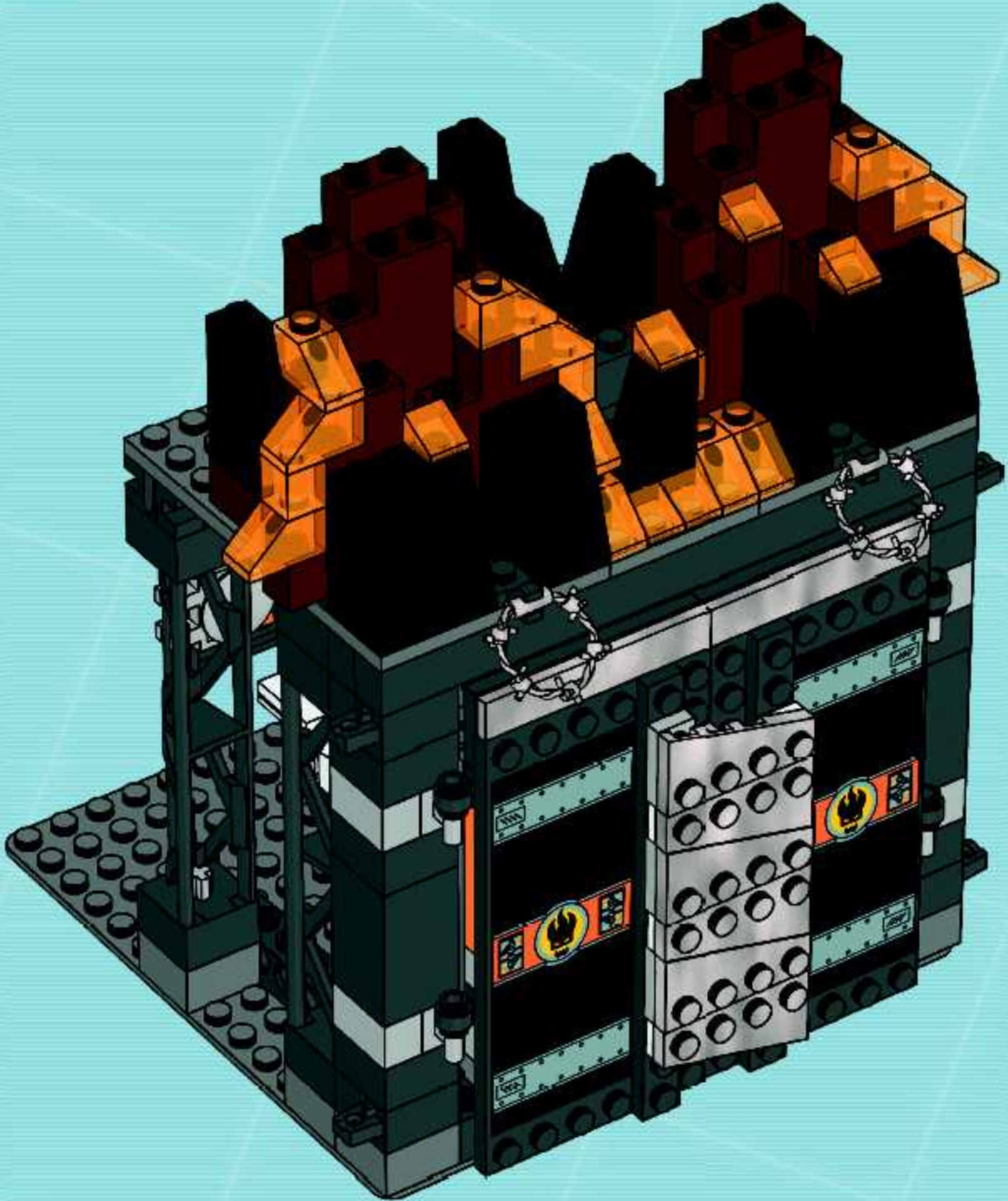





3x



2x

# 25

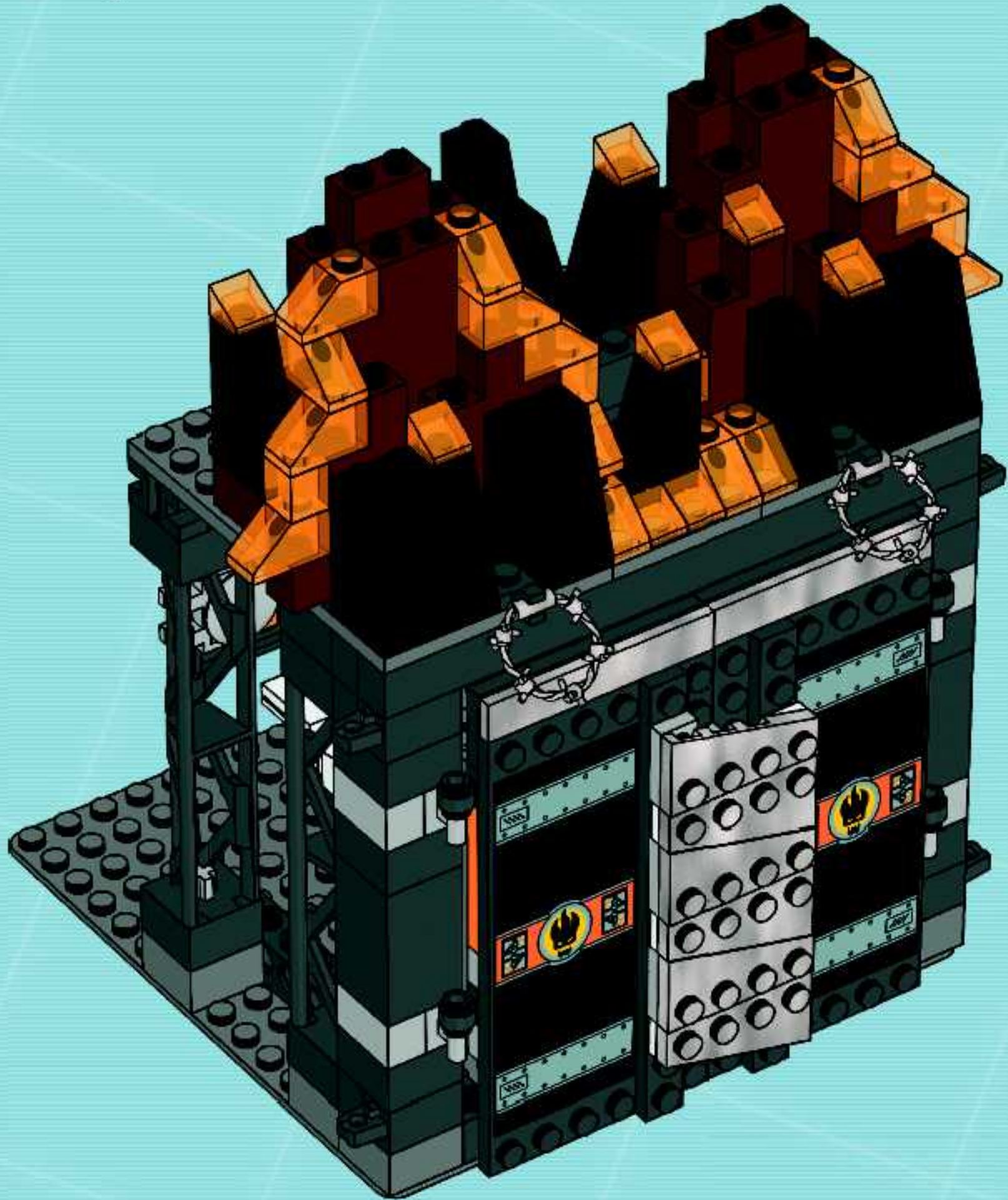



26

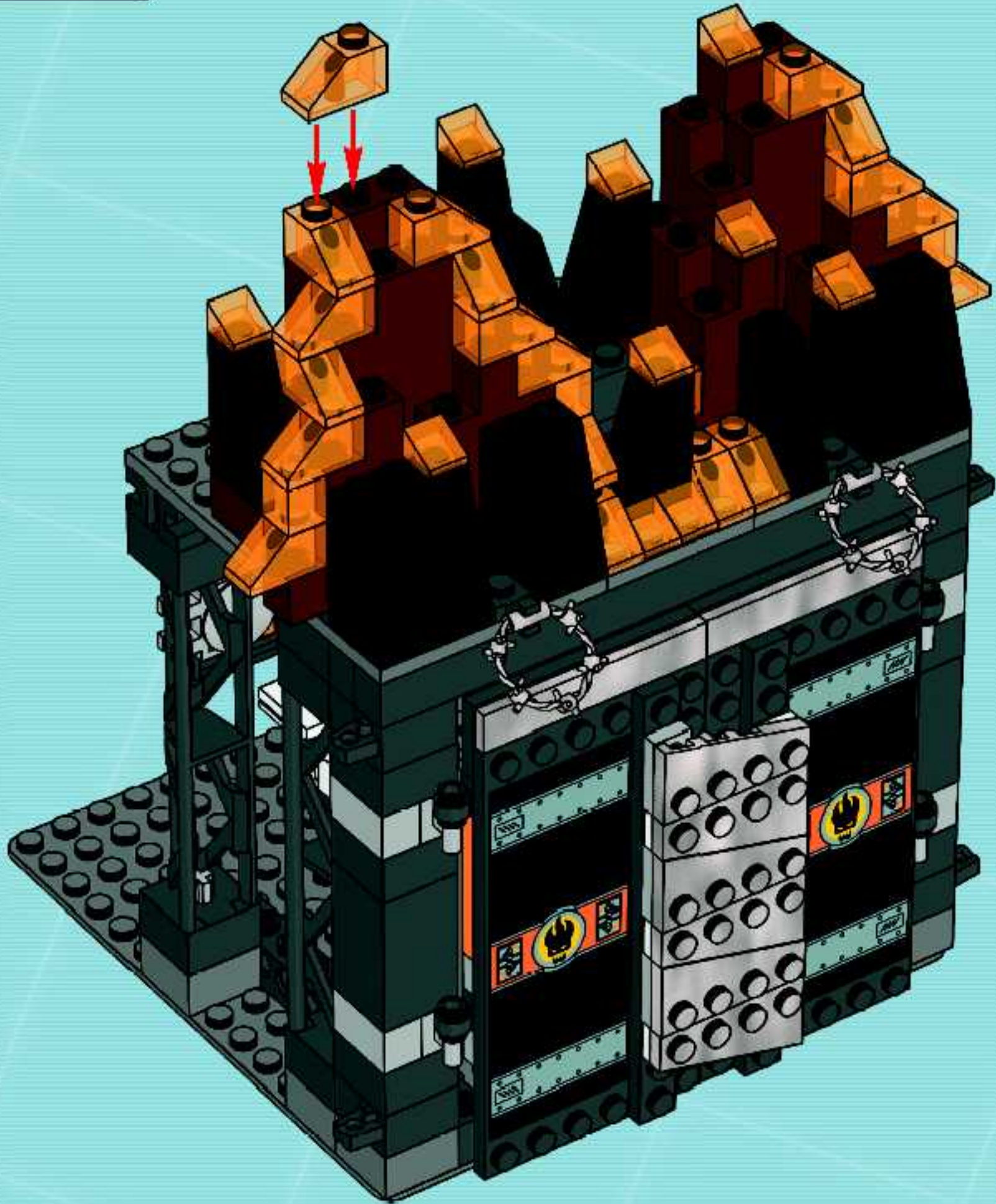



27

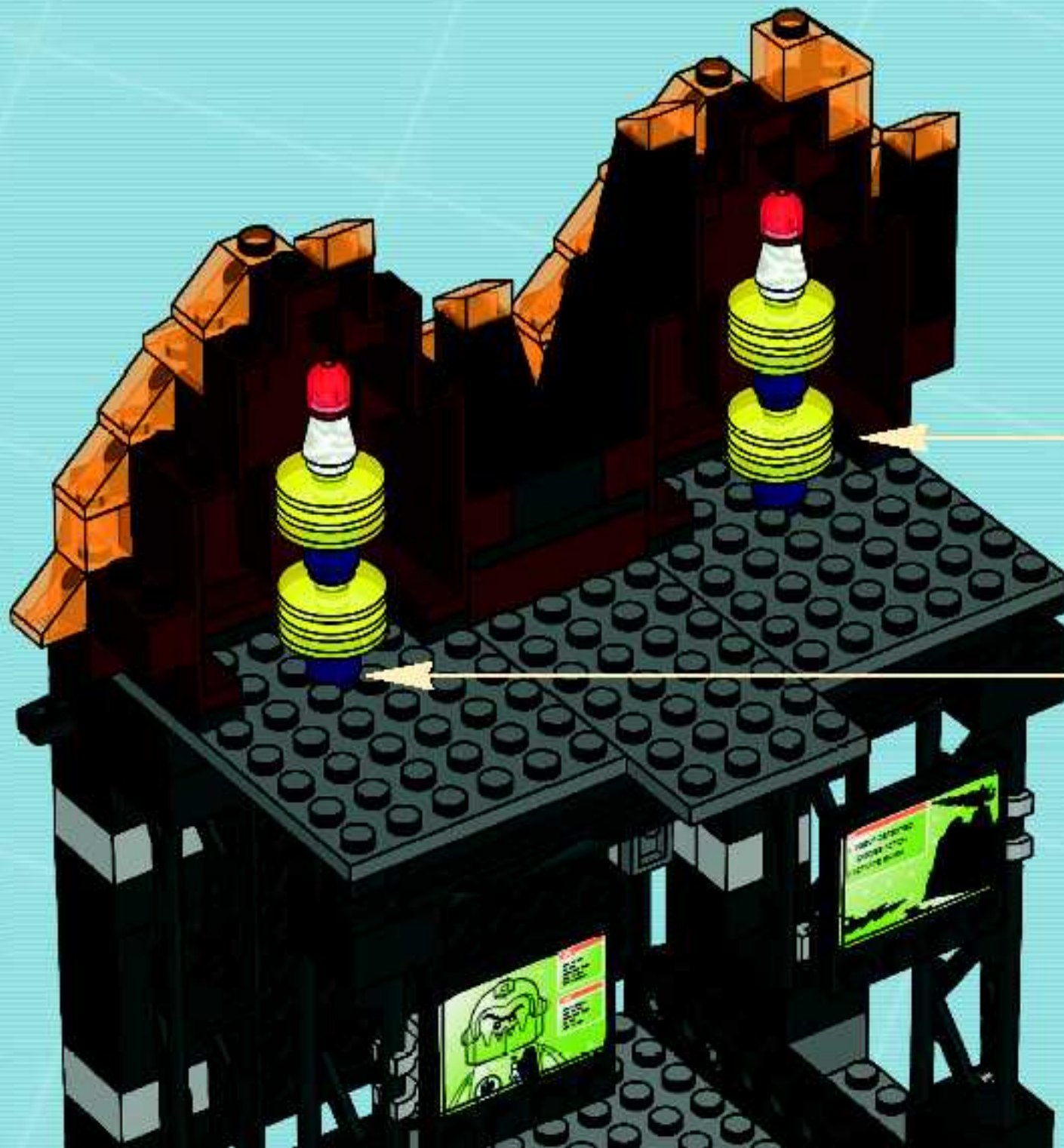
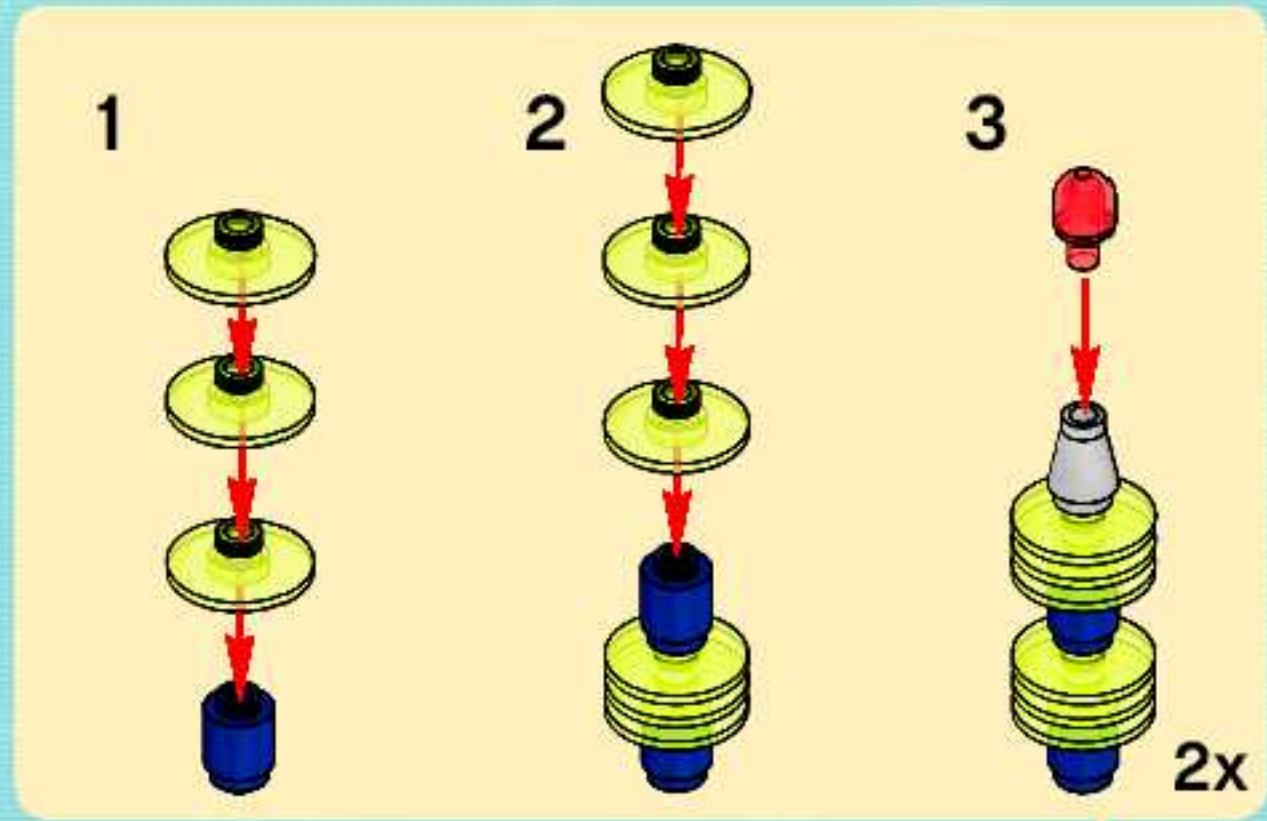

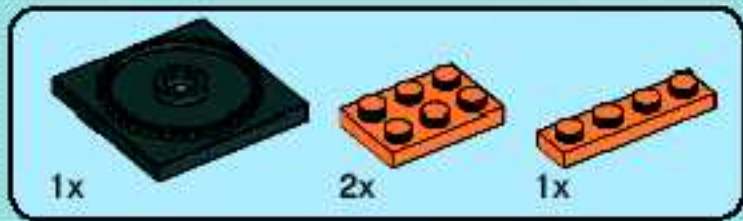

28

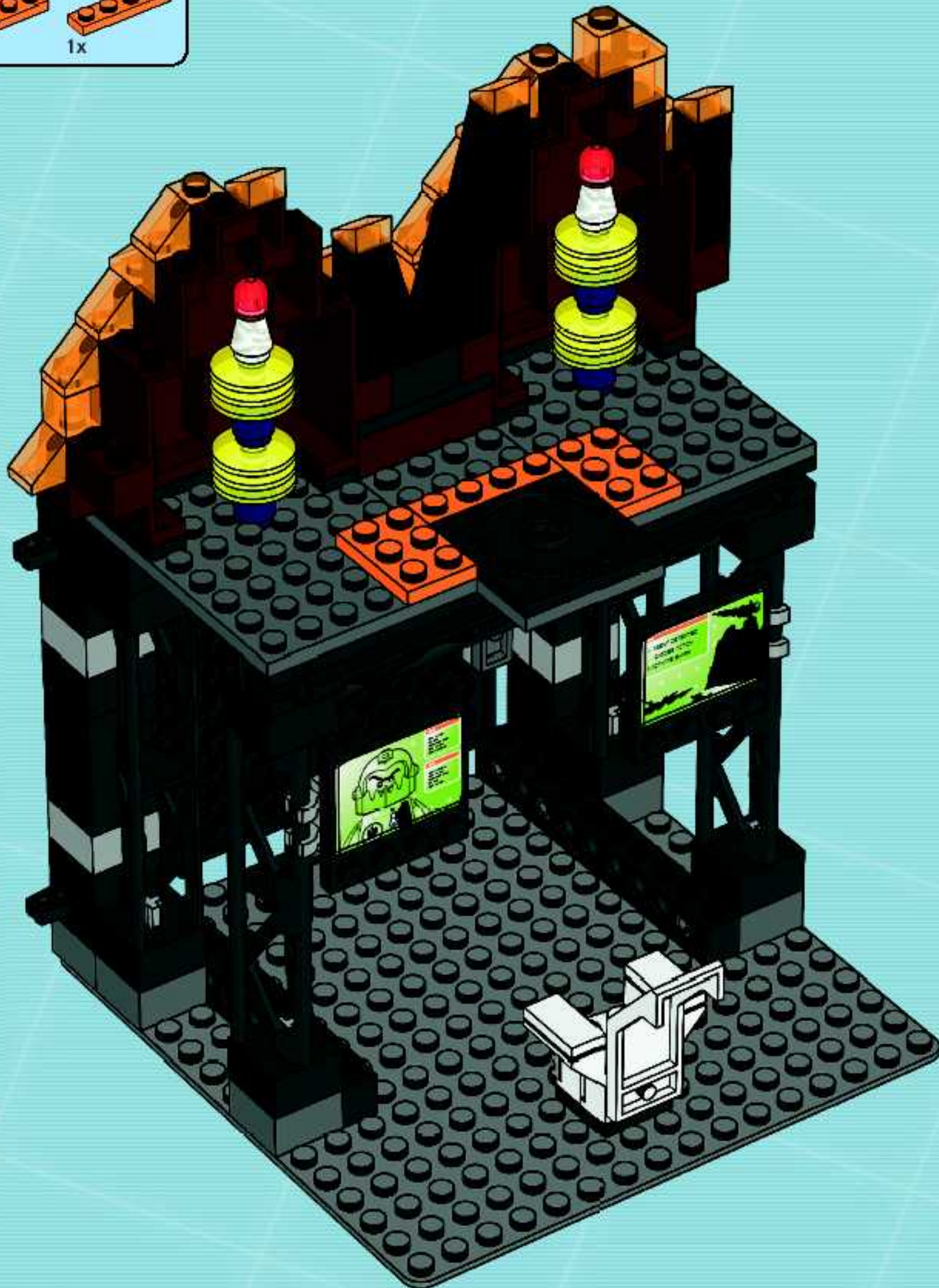



29

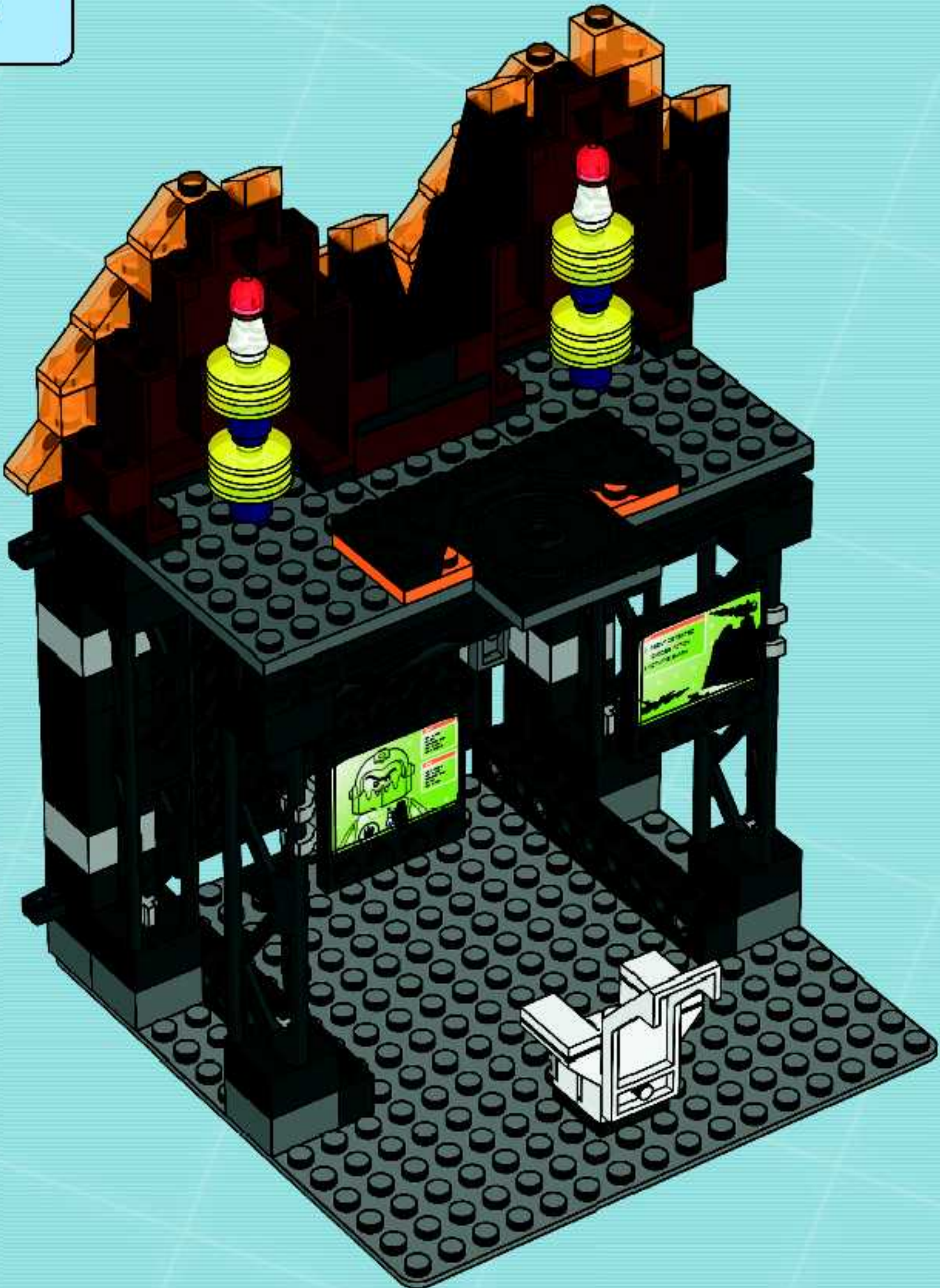



1

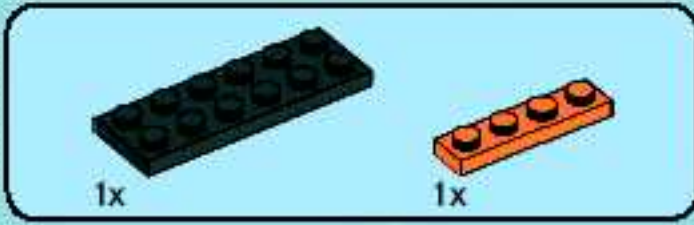
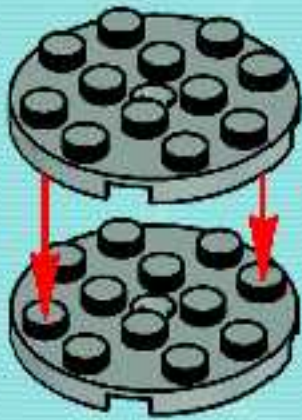

2



3

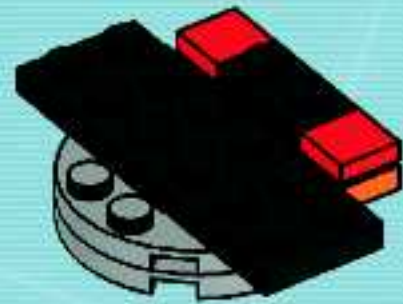

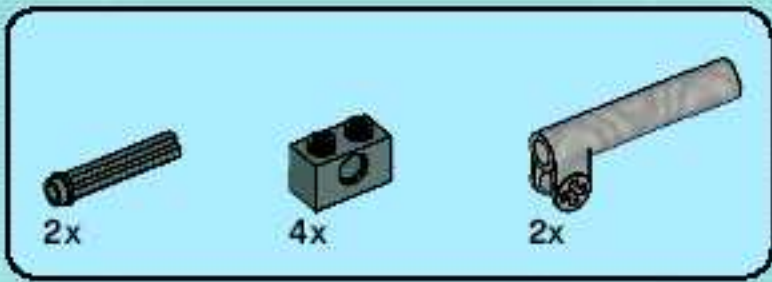

4

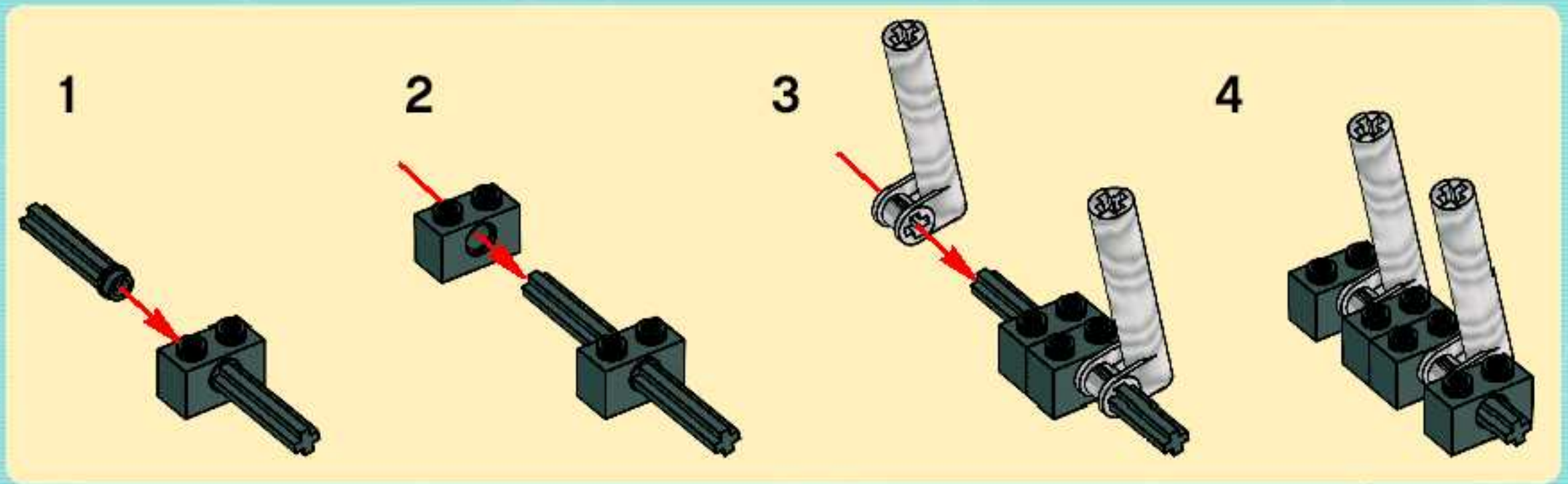

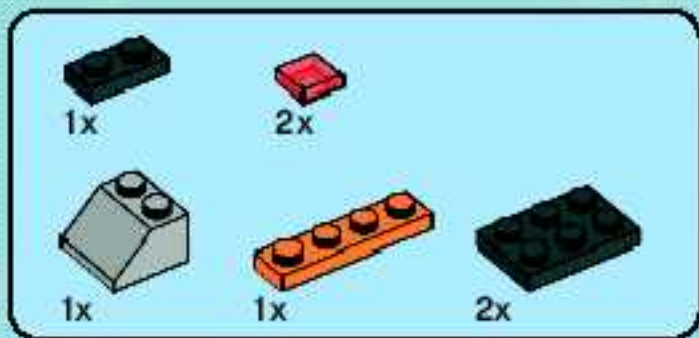

5

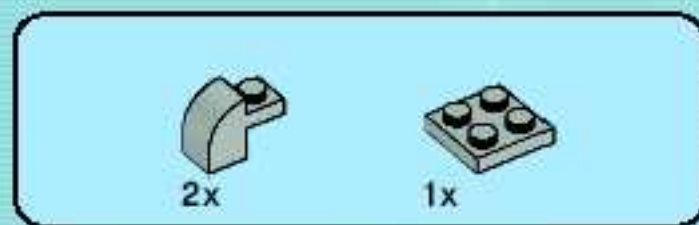
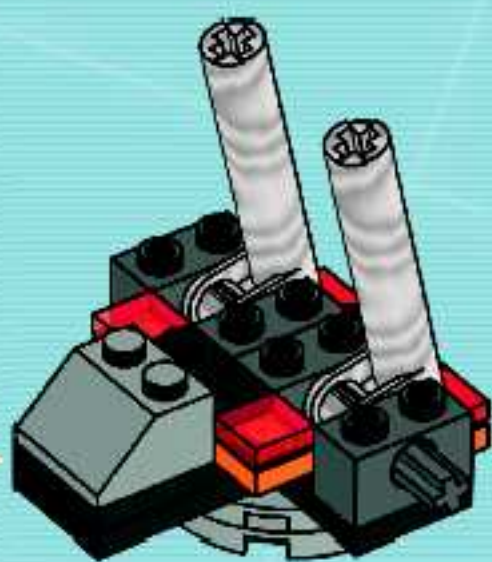
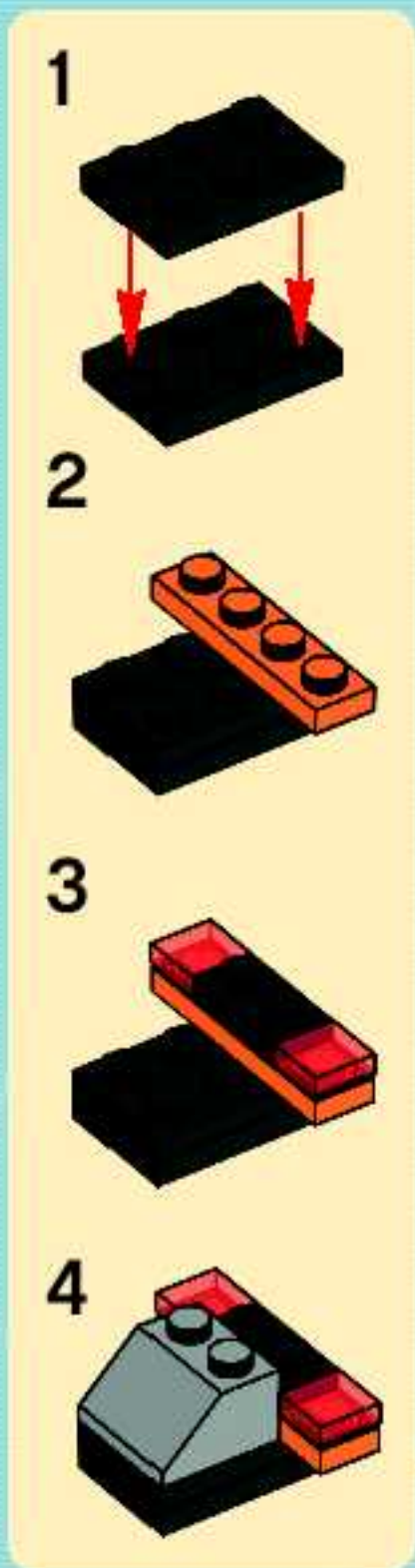

6

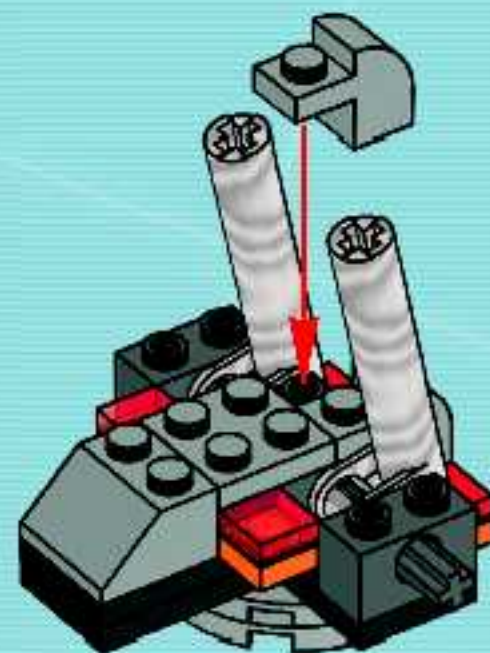

7

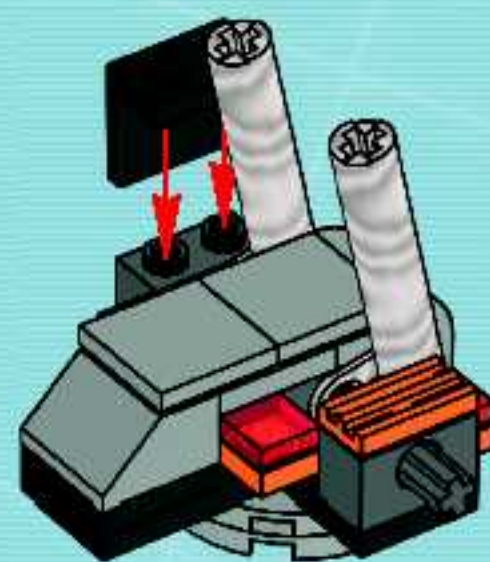





8

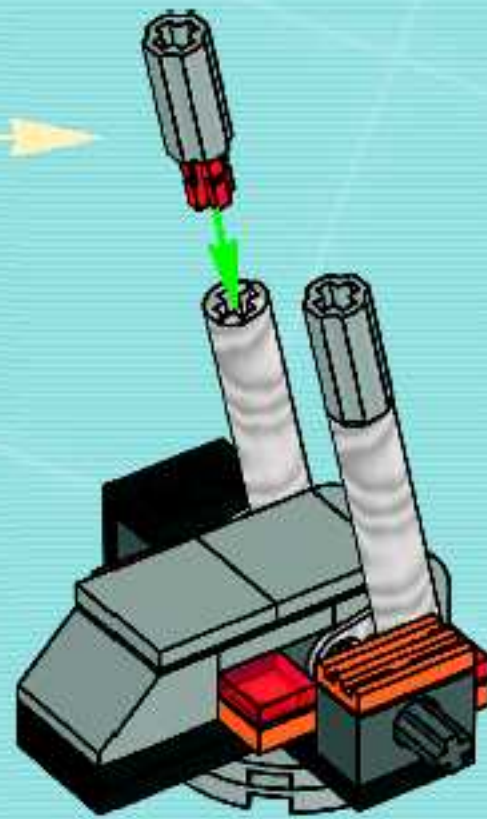

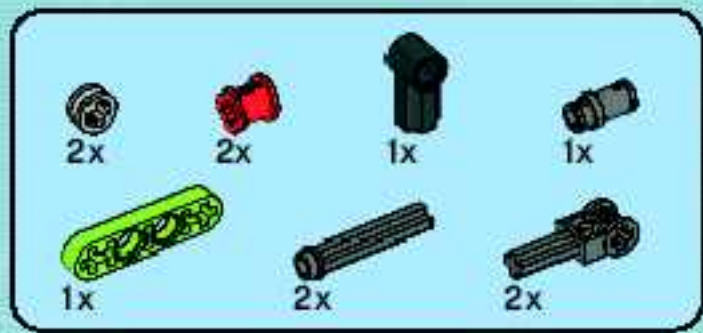

9

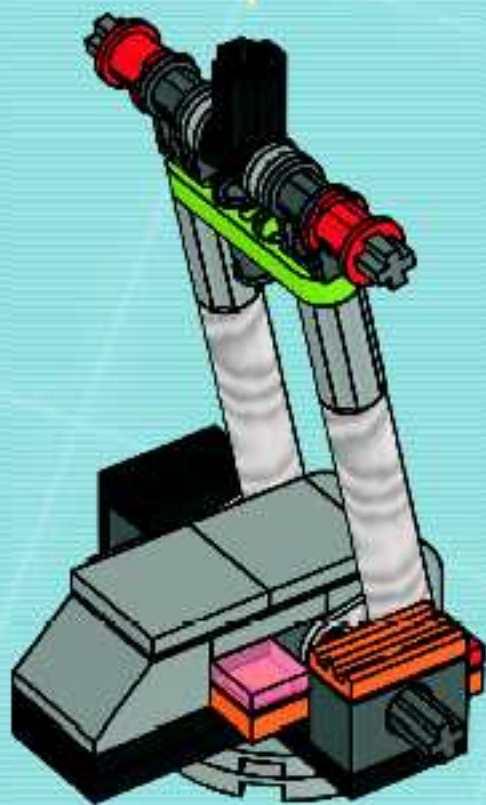
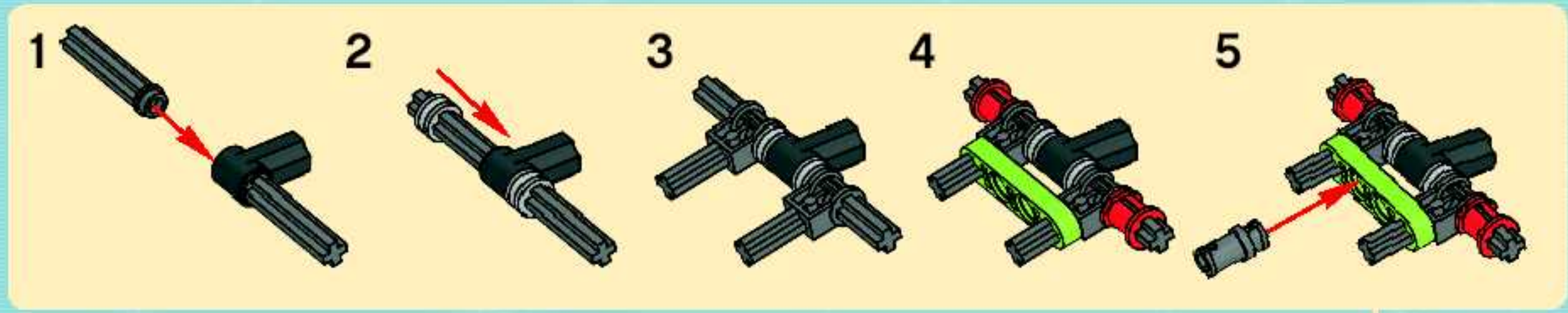



10

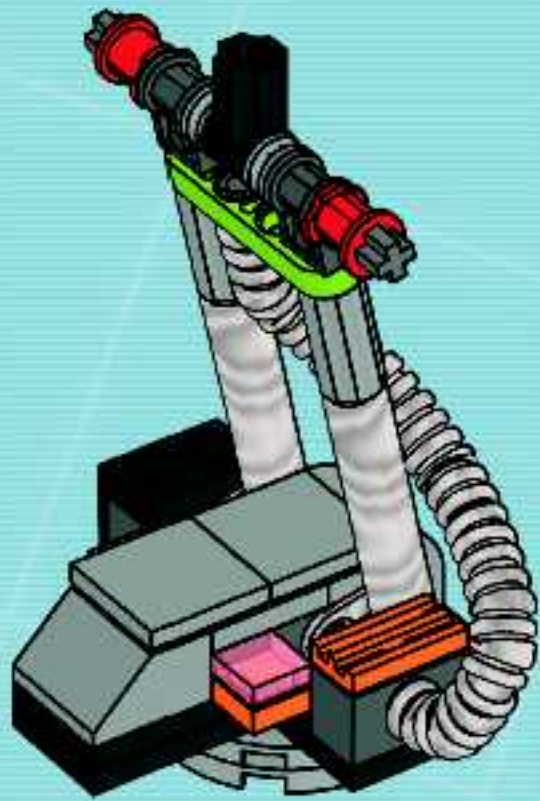

30

