



CREATOR

6910





1

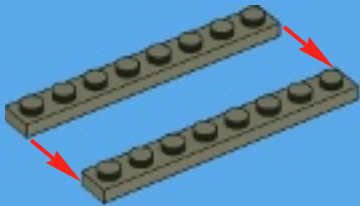

2

2

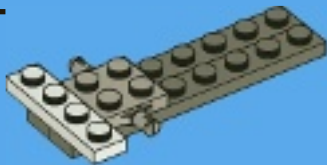

3



4



5

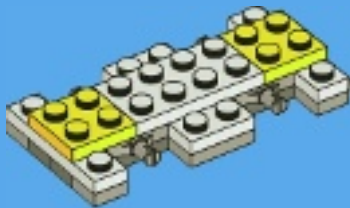

6

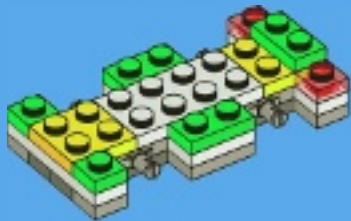

7

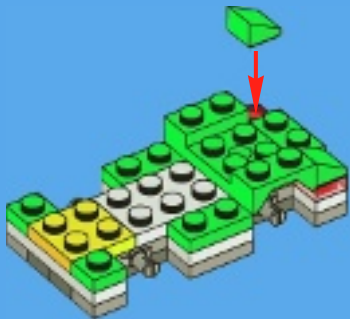

8



9



10



11

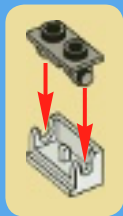
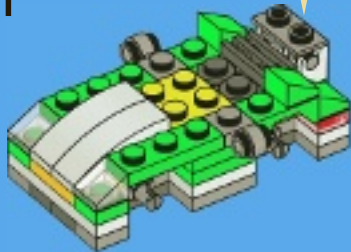

12

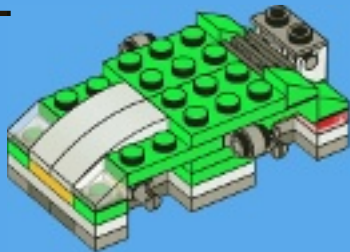

13

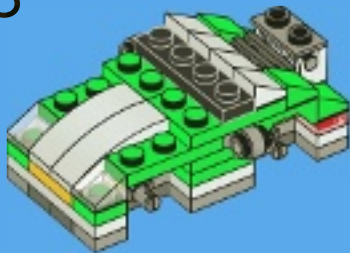

14

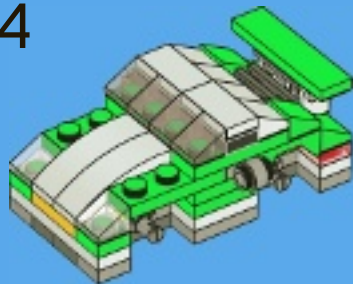

15

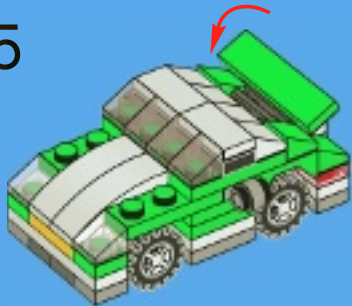



1

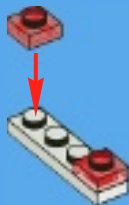

2



3



4

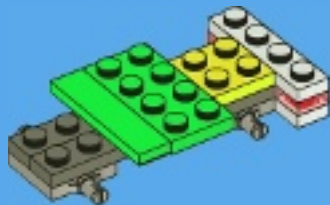

5

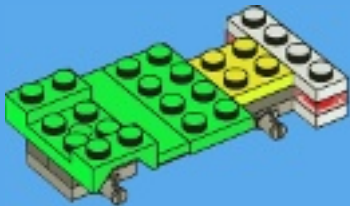

6



7

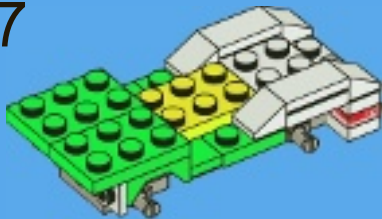

8

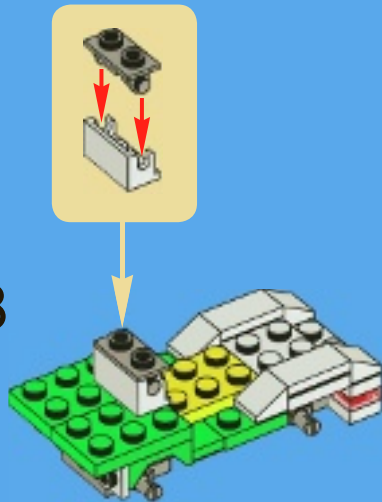

9

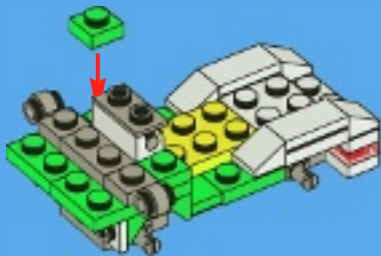

10

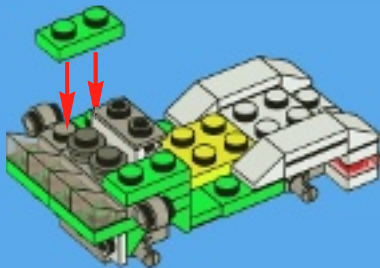

11

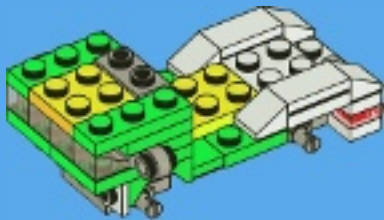

12

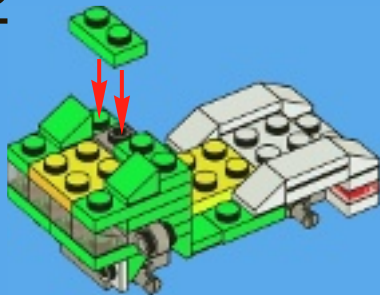

13

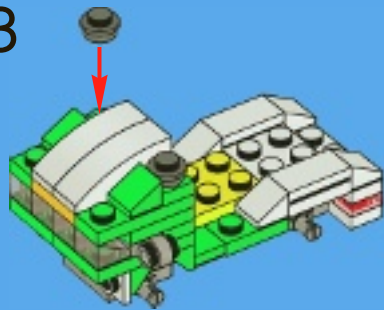

14



1



2



3



15





1

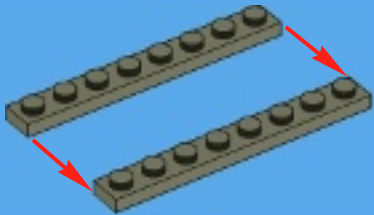

2

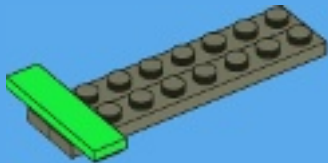

3

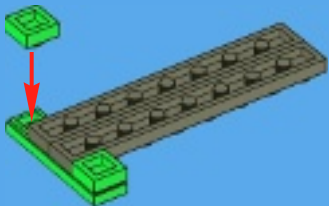

4

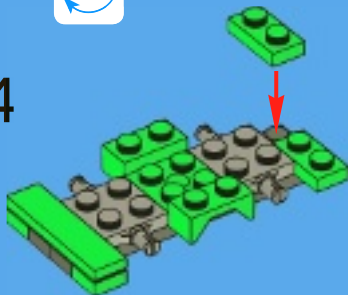

5

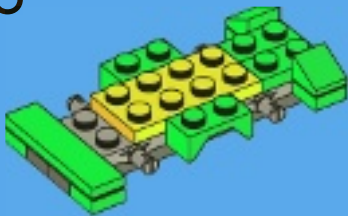

1



2

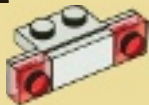

6

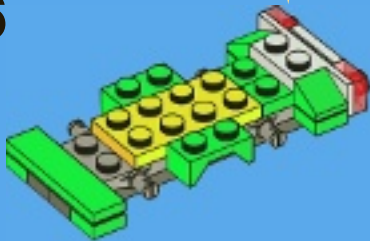

7

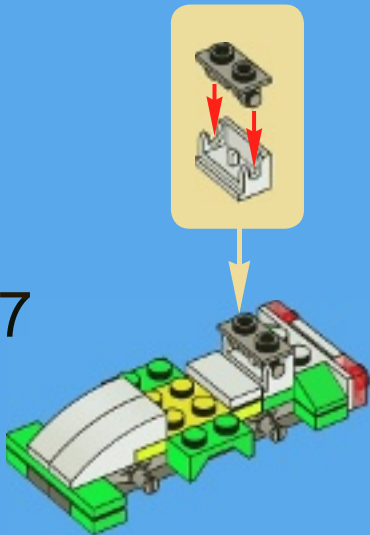

8

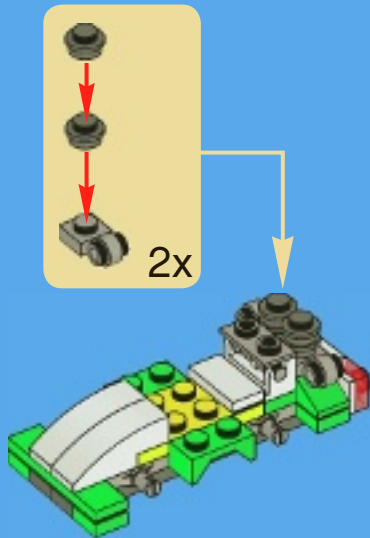

9

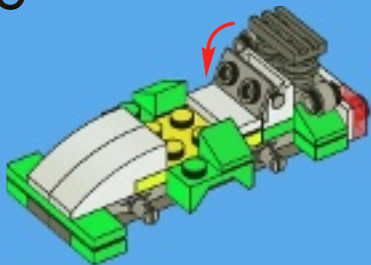

22

10

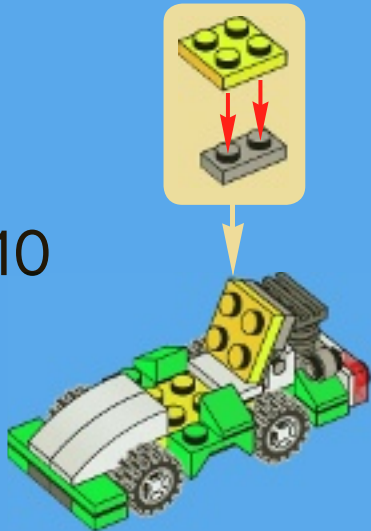



4x
4504369



2x
4249112



2x
306901



2x
371001



2x
302001



1x
4282737



4x
462401



1x
393701



3x
302224



1x
302024



1x
371026



4x
4578677



4x
4546705



2x
302428



4x
302328



2x
4107758



2x
302128



1x
243128



1x
302028



1x
4649407



4x
4244368



2x
3000841



2x
4244362



4x
4211399



2x
4211398



2x
4632575



2x
4211504



1x
4211470



1x
4210631



4x
4210633



2x
4210998



Customer Service

Kundenservice



Service Consommateurs

Servicio Al Consumidor

www.lego.com/service or dial



     : 00800 5346 5555

  : 1-800-422-5346



CREATOR

6912



6913



7291



6914



7292



LEGO and the LEGO logo are trademarks of the/sont des marques de commerce de/son marcas registradas de LEGO Group. ©2012 The LEGO Group.

creator.LEGO.com
4656079 / 4656116



www.LEGO.com

