

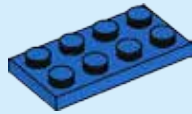

1

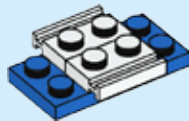

2



3

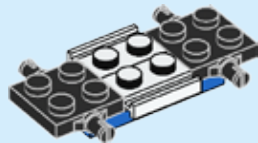

4



5

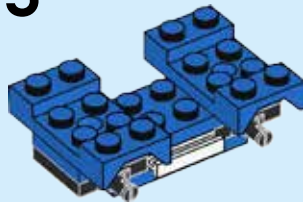

6

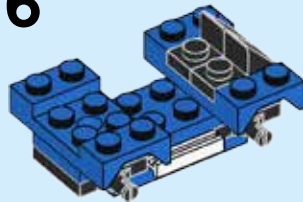

7

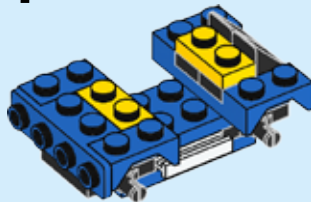

8

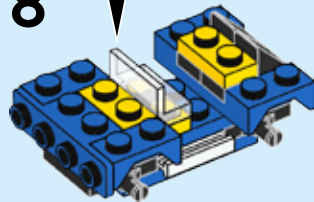

9

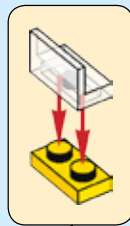
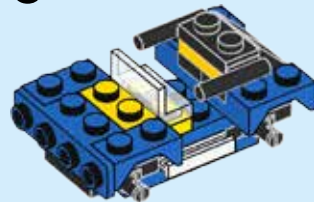

10

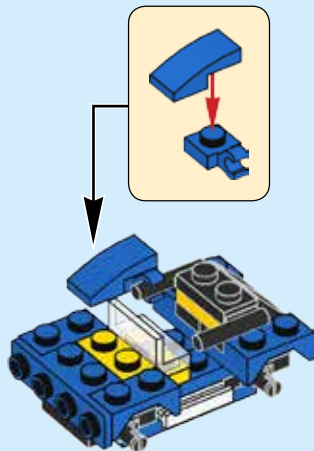

11

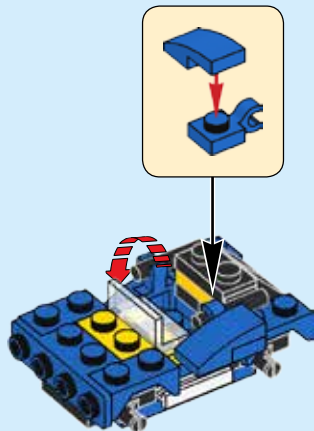

12

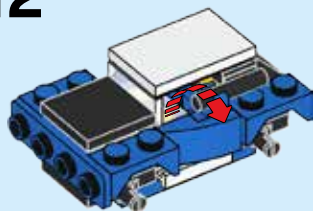

13

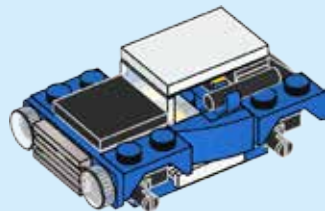

14

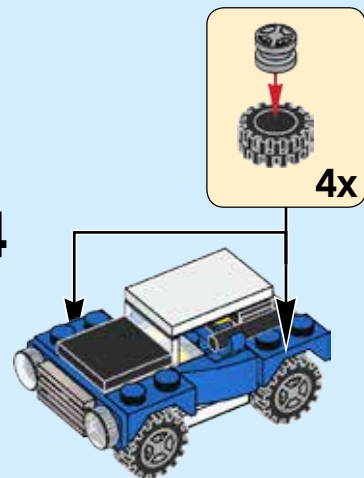

LEGO.com/service

LEGO and the LEGO logo are trademarks of the/son
marques de commerce du/son marcas registradas de
LEGO Group. ©2017 The LEGO Group.

6188847